

OPERATOR MANUAL

**Reliance® 400 Laboratory Glassware Washer
Reliance® 500 Laboratory Glassware Washer**

(2007-06-27)

P122994-513

A WORD FROM STERIS CORPORATION

This manual contains important information on the proper use and routine maintenance of the Reliance® 400 Laboratory Glassware Washer and the Reliance® 500 Laboratory Glassware Washer. **All personnel involved in the use and maintenance of this equipment must carefully review and comply with the *Safety Precautions and instructions contained in this manual.*** These instructions are important to protect the health and safety of personnel operating this glassware washer and should be retained in a conveniently accessible area for quick reference. This equipment is specifically designed only for the uses outlined in this manual.

Complete instructions for uncrating and connecting utilities, as well as the equipment drawing, have been provided. If they are missing, contact STERIS for replacement copies, providing the serial number and model of the glassware washer.

Advisory

IMPORTANT: A listing of the *Safety Precautions to be observed when operating and servicing this glassware washer can be found in SECTION 1 of this manual. Do not operate the equipment until you have become familiar with this information.*

Any alteration of this equipment not authorized or performed by STERIS will void the warranty. Alteration of equipment which could adversely affect its operation and efficacy may violate national, state and local regulations.

To help ensure operators are adequately trained in the safe use of this equipment, STERIS recommends:

- all personnel who operate or maintain the equipment are trained in its operation and in its safe use;
- personnel working with toxic chemicals and vapors (if applicable) have comprehensive instructions in the glassware washer process, relevant health hazards and methods to detect and avoid exposure to the escape of toxic materials;
- there is regular training of all personnel concerned with operation and maintenance of the equipment; attendance records are maintained; and evidence of understanding is demonstrated.
- current Material Safety Data sheets (MSDS) should be available to all users in the department. For current MSDS sheets, contact STERIS.

Indications For Use

Reliance 400 and Reliance 500 Laboratory Glassware Washers are intended for use in cleaning of laboratory glassware, plasticware and metal goods used in research, production support and quality control laboratories. This washer is specifically designed to only process goods as outlined in this manual. If there is any doubt about a specific material or product, contact product manufacturer for recommended washing technique.

Service Information

A thorough preventive maintenance program is essential to help ensure safe and proper equipment operation. This manual contains maintenance schedules and procedures which should be followed for satisfactory equipment performance.

Customers are encouraged to contact STERIS concerning our comprehensive annual maintenance program. Under the terms of the program, preventive maintenance, adjustments and replacement of worn parts are performed on a scheduled basis to help ensure equipment performance at peak capability and to help avoid untimely and costly interruptions. STERIS maintains a global staff of well-equipped, qualified service technicians to provide this service, as well as expert repair services. Please contact STERIS for details.

STERIS provides a complete line of accessories for use with this equipment. A STERIS representative will gladly review these with you.

NOTE: Certain options may not be available in your area. Contact STERIS for product availability and ordering information.

Certification

Reliance 400 Laboratory Glassware Washer and **Reliance 500 Laboratory Glassware Washer** meet the applicable requirements of the following standards, as certified by UL:

Underwriters Laboratories Standard (UL):

UL 61010-1, Second Edition.

Canadian Standards Association (CSA):

CAN/CSA-C22.2 No. 61010-1, Second Edition.



Governing directive for the affixing of the CE mark:

Machinery Directive 98/37/EC.

Conformity to other applicable directives:

Electromagnetic Compatibility Directive (89/336/EEC) amended by Directive 91/263/EEC, Directive 92/31/EEC and Directive 93/68/EEC.

Low Voltage Directive 73/23/EEC amended by Directive 93/68/EEC.

Standards applied to demonstrate conformity to the directives:

International Standard IEC 61010-1, Second Edition.

International Standard IEC 61326-1.



Corporation STERIS Canada Québec, Qc, CANADA	ISO 13485 ISO 9001 Certified Facility
--	--

The base language of this document is **ENGLISH**. Any translations must be made from the base language document.

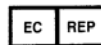

STERIS Limited
STERIS House
Jays Close
Viables
Basingstoke
Hampshire
RG22 4AX
United Kingdom

Sales and Service:

STERIS Corporation
5960 Heisley Road
Mentor, Ohio 44060
440-354-2600 • 800-444-9009

www.steris.com

TABLE OF CONTENTS

Section Number	Description	Page
A WORD FROM STERIS CORPORATION.....i		
	Advisory.....	i
	Indications For Use.....	ii
	Service Information.....	ii
	Certification.....	iii
1	SAFETY PRECAUTIONS	1-1
2	INSTALLATION VERIFICATION.....	2-1
	2.1 Technical Specifications.....	2-1
	2.1.1 Voltage, Amperage and Power Consumption.....	2-1
	2.1.2 Noise Level.....	2-2
	2.1.3 Permissible Environmental Conditions.....	2-2
	2.1.4 Seismic Anchorage System	2-2
	2.2 Installation Checklist.....	2-2
	2.3 Detergents and Chemical Additives Specifications	2-4
3	COMPONENT IDENTIFICATION.....	3-1
	3.1 Before Operating Glassware Washer.....	3-1
	3.2 Control Location	3-2
	3.2.1 Power Switch.....	3-2
	3.2.2 POWER-OFF/STANDBY Switch.....	3-2
	3.2.3 Printer	3-2
	3.3 Load Side Control Panel.....	3-4
	3.3.1 Display Screen.....	3-4
	3.3.2 Touch Pads	3-4
	3.4 Unload Side Control Panel	3-5
4	OPERATING INSTRUCTIONS	4-1
	4.1 Before Operating Equipment.....	4-1
	4.2 Priming Procedure.....	4-2
	4.3 Accessories.....	4-3
	4.4 Loading Glassware Washer	4-6
	4.4.1 Universal Shelving System (Optional).....	4-6
	4.4.2 Universal Shelving System (Optional) – Reliance 400	4-6
	4.4.3 Universal Shelving System (Optional) – Reliance 500	4-8

Continued...

TABLE OF CONTENTS (Cont'd)

Section Number	Description	Page
4	OPERATING INSTRUCTIONS (Cont'd)	
4.5	Typical Cycle Operation	4-9
4.6	Extend Cycle Treatment	4-13
4.7	Acknowledge Alarm Condition	4-14
4.8	Stop Cycle Operation	4-15
4.9	Abort Cycle Operation	4-16
4.10	Shutdown	4-16
4.11	Power Door Operation	4-18
4.11.1	Door Obstruction	4-18
4.11.2	Power Door Operation During a Power Failure	4-19
5	CYCLE AND CONTROL VALUE PROGRAMMING	5-1
5.1	General	5-1
5.2	Change Values Mode	5-3
5.3	Treatment Sequence and Display Screens	5-4
5.4	Modifying Factory-Set Cycles	5-5
5.5	Adding Cycle Treatments	5-9
5.6	Creating Custom Cycles	5-13
5.7	Removing Treatments From Cycles	5-16
5.8	Changing Miscellaneous Values	5-20
5.9	Select Injection Time Rate	5-25
5.9.1	General	5-25
5.9.2	Verifying Chemical Concentration	5-29
5.10	Programming Values With Access Code Enabled	5-30
5.11	Review Cycle Values	5-31
6	ROUTINE MAINTENANCE	6-1
6.1	General	6-1
6.2	Preventive Maintenance	6-2
6.3	Daily Cleaning	6-4
6.4	Weekly Cleaning	6-4
6.5	Monthly Cleaning	6-5
6.5.1	Remove Hard Water Deposits	6-5
6.5.2	Clean Building Supply-Line Strainers	6-6

Continued...

TABLE OF CONTENTS (Cont'd)

Section Number	Description	Page
6	ROUTINE MAINTENANCE (Cont'd)	
6.6	Chemical Container Replacement.....	6-6
6.7	Inspect and Lubricate Peristaltic Injection Pump Squeeze Tubes.....	6-7
6.8	Verify Power Doors	6-8
6.9	Changing Printer Paper Roll.....	6-8
6.10	Storing Thermal Paper.....	6-10
7	TROUBLESHOOTING.....	7-1

LIST OF ILLUSTRATIONS





Figure	Description	Page
Section 3: Component Identification		
3-1	Component Identification.....	3-1
3-2	Printer and Front Control Panel.....	3-3
Section 4: Operating Instructions		
4-1	Chemical Container	4-1
4-2	Bottom Rotary Spray Headers	4-4
4-3	Glassware Support	4-5
4-4	Pipette Header	4-5
4-5	Universal Shelving System (Reliance 500 Shown)	4-7
4-6	Universal Shelving System – Reliance 400.....	4-7
4-7	Universal Shelving System – Reliance 500.....	4-7
4-8	Printout With Extended Cycle Treatment	4-13
4-9	Power Door Operation During a Power Failure.....	4-19
4-10	Safety Door Stop (Reliance 400 Only).....	4-20
Section 5: Cycle and Control Value Programming		
5-1	Change Values Mode Functions.....	5-3
5-2	Change Values Mode – Program Tree	5-3
5-3	Change Values Mode – Modifying Cycle Treatments	5-6
5-4	Change Values Mode – Adding Cycle Treatments	5-10
5-5	Change Values Mode – Creating Custom Cycles	5-14
5-6	Change Values Mode – Removing Treatments From Cycles	5-17
5-7	Change Values Mode – Changing Miscellaneous Values	5-21
5-8	Change Values Mode – Select Injection Time Rate.....	5-26
5-9	Sample Port	5-29
5-10	Change Values Mode – Programming With Access Code Enabled	5-30
Section 6: Routine Maintenance		
6-1	Changing Printer Paper Roll	6-9

SAFETY PRECAUTIONS



1

The following *Safety Precautions* **must** be observed when operating or servicing this Reliance® 400 Laboratory Glassware Washer or this Reliance® 500 Laboratory Glassware Washer. WARNING indicates the potential for personal injury and CAUTION indicates the potential for damage to equipment. For emphasis, certain *Safety Precautions* are repeated throughout the manual. **It is important to review ALL Safety Precautions before operating or servicing the glassware washer.**



WARNING – PERSONAL INJURY AND/OR EQUIPMENT DAMAGE HAZARD:

-  Always load baskets on appropriate loading cart or surface.
-  If an obstruction is present in wash chamber door, door safety sensor will detect obstruction and door will automatically stop closing. Wait until door is fully open and water flow has stopped before removing obstruction.
-  If an obstruction is present in wash chamber door and door is unable to raise, DO NOT attempt to remove obstruction from under door. Door cables may have loosen which could cause door to close at high speed when obstruction is removed. Call a qualified service technician to safely remove an obstruction.
-  Regularly scheduled preventive maintenance is required for safe and reliable operation of this equipment. Contact STERIS to schedule preventive maintenance.
-  Repairs and adjustments to this equipment must be made only by STERIS or STERIS-trained service personnel. Repairs and adjustments performed by unqualified personnel or installation of unauthorized parts could cause personal injury, result in improper equipment performance, void the warranty or result in costly damage. Contact STERIS regarding service options.

WARNING – PERSONAL INJURY HAZARD:

-  Chamber door is heavy. Lifting it manually may require two people.
-  In case of power loss, power door(s) lowers slowly by gravity. Keep hands and items out of door area to avoid personal injury.

WARNING – ELECTRIC SHOCK AND/OR BURN HAZARD:

-  Fasteners and star washers are used to ensure protective bonding continuity. Always reinstall any star washer which may have been removed during installation or servicing.
-  STERIS strongly recommends service be performed only by STERIS or STERIS-trained service personnel. Service personnel must disconnect all utilities to unit before servicing. No one should service unit unless all utilities have been properly locked out. Always follow local electrical codes and safety-related work practices.

WARNING – POSSIBLE FIRE HAZARD:

When glassware washer is installed on a combustible floor, floor must be covered with a metal sheet extending to the outer edges of glassware washer.

WARNING – CHEMICAL BURN AND/OR EYE INJURY HAZARD:

Detergents are caustic and can cause adverse effects to exposed tissues. Do not get in eyes, on skin or attempt to swallow. Read and follow the precautions and instructions on the detergent label and in the Material Safety Data Sheet (MSDS) prior to handling the detergent, refilling the detergent container or servicing the detergent injection pump and lines. Wear appropriate Personal Protective Equipment (PPE) whenever handling the detergent or servicing the detergent injection pump and lines.



Wear appropriate Personal Protective Equipment (PPE) when using a descaling product. Avoid contact with the eyes or skin. If a descaling product spills or splashes on you, flush the affected area with water for 15 minutes. If swallowed, DO NOT induce vomiting. Administer an alkali with plenty of water. Seek medical attention immediately.

WARNING – BURN HAZARD:

After pressing STOP/RESET touch pad, wait until water flow stops before slowly opening door. Hot water/steam may be sprayed through door opening if door is opened too soon.



Allow piping to cool before inspecting and/or cleaning supply-line strainers.



Except for an emergency, do not open door when cycle is in progress. In an emergency, first stop cycle by pressing STOP/RESET touch pad and wait for water flow to stop. Wear appropriate Personal Protective Equipment (PPE) whenever reaching into chamber.



Wear appropriate Personal Protective Equipment (PPE) and open door slowly if it is necessary to open during a cycle. Hot water/steam may be sprayed through door opening when verifying automatic stop while washer is operating.

WARNING – SLIPPING HAZARD:

To prevent slips, keep floors dry. Promptly clean up any spills or drippage. For spills or drippage of detergents or other chemicals, follow safety precautions and handling procedures set forth on detergent or chemical label and/or Material Safety Data Sheet (MSDS).

CAUTION – POSSIBLE EQUIPMENT DAMAGE:

Always position each manifold and/or bottom rotary spray over a manifold connector before operating unit. If manifolds and/or bottom rotary sprays are not positioned correctly, damage will result and unit will be unable to effectively wash load.



Always position each accessory header over a manifold connector before operating unit. If accessory headers are not positioned correctly, damage may result and unit will be unable to effectively wash load.

CAUTION – POSSIBLE EQUIPMENT DAMAGE (Cont'd):



Always select a cycle appropriate for the items being processed. Failure to do so may result in product damage.



Always use a silicone lubricant to lubricate squeeze tubes. Petroleum-based lubricants, such as Vaseline¹ or grease, will cause squeeze tubes to melt.



Once chamber door has been lowered, ensure cable is correctly aligned and routed on all six cable pulleys.



Use nonabrasive cleaners when cleaning unit. Follow directions on containers and rub in a back-and-forth motion (in same direction as surface grain). Abrasive cleaners will damage stainless steel. Cleaners rubbed in a circular motion or applied with a wire brush or steel wool on door and chamber assemblies can be harmful to stainless steel. Do not use these cleaners on painted surfaces.



When choosing a detergent, select one with a low-chloride content. Detergents with a high-chloride content must not be used, as such detergents may harm stainless steel.

¹ Vaseline is a trademark of Chesebrough Pond's Incorporated.

Table 1-1 contains symbols which may be on your Reliance 400 or Reliance 500 Laboratory Glassware Washers components:

Table 1-1. Definition of Symbols on Glassware Washer







Symbol	Definition
	Protective Earth (Ground).
	Warning! Risk of Electrical Shock.
	Attention. Refer to Manual For Further Instructions.
	ON (For Part of Equipment).
	OFF (For Part of Equipment).
	Transfer of Heat, Hot Surface.

Table 1-2 contains symbols which may be on the identification nameplate of your Reliance 400 or Reliance 500 Laboratory Glassware Washers:

Table 1-2. Definition of Symbols on Identification Nameplate

Symbol	Definition
MODEL	Model of Unit.
S/N	Serial Number of Unit.
kVA	Power Rating of Unit.
V_~	Volt, Number of Phase (3 or 1), Alternating Current.
A	Amperage Rating of Unit.
Year	Year of Manufacture of Unit.
Hz	Hertz – Frequency of Unit.
WIRE	Number of Wires in Electrical Cable Excluding Protective Ground Wire.

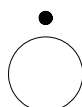
2.1 Technical Specifications

These specifications are intended to describe the technical information given on the identification nameplate of the Reliance® 400 Laboratory Glassware Washer or the Reliance® 500 Laboratory Glassware Washer and to state other relevant information. Verify equipment drawing (122992-953 for Reliance 400 or 122993-554 for Reliance 500) or identification nameplate (located in the middle section of lower service access panel compartment, on load side or on right bottom corner load side) for proper voltage and amperage.

2.1.1 Voltage, Amperage and Power Consumption

Both Laboratory Glassware Washers operate either on:

- 120/208 V, 60 Hz, three-phase, four-wire, steam-heated;
- 480 V, 60 Hz, three-phase, three-wire, steam-heated;
- 380/400/415 V, 50 Hz, three-phase, three-wires, steam-heated;
- 600 V, 60 Hz, three-phase, three-wire, steam-heated;
- 480 V, 60 Hz, three-phase, three-wire, electric-heated;
- 380/400/415 V, 50 Hz, three-phase, three-wire, electric-heated;
- 600 V, 60 Hz, three-phase, three-wire, electric-heated.
- **Maximum currents and power consumptions** are indicated on identification nameplate (refer to Figure 3-1).
- A protective ground conductor is required (Class 1 Equipment).
- Main supply voltage fluctuation not exceeding ± 10 percent of nominal voltage.
- Installation Category: Overvoltage Category II.
- Overvoltage attenuation must be provided. Equipment must be connected in a way to reduce transient voltage at electrical main supply. Overvoltage attenuation can be achieved by:
 - a. connecting equipment main supply to a distribution system with multiple branch circuits;
 - b. connecting equipment main supply through an isolating transformer (380/400/415 V [input, output], three-phase, 30 kVA; 208 V [input, output], three-phase, 15 kVA; 480 V [input, output], three-phase, 30 kVA; or 600 V [input, output], three-phase, 30 kVA).

IMPORTANT: *Customer is responsible for compliance with applicable codes and regulations.*

Refer to *Uncrating/Installation Instructions* (P122996-649) for proper connection.

2.1.2 Noise Level

Equivalent Sound Pressure Level at work station, measured 36" (1.0 m) away from equipment and at 63" (1.6 m) from ground: **67.6 dB (A)**. Results determined according to ISO-3746:1979 *Standard: Acoustics Determination of Sound Power Levels of Noise Sources Survey Method*).

2.1.3 Permissible Environmental Conditions

This glassware washer is designed to give optimal results under the following conditions:

- Indoor use only;
- Altitude of operation up to 6,562 ft (2,000 m);
- Temperature of 41 to 104°F (5 to 40°C);
- Maximum relative humidity is 80% for temperatures up to 88°F (31°C), decreasing linearly to 50% relative humidity at 104°F (40°C);
- Pollution Degree 2.

Pollution degree 2: Equipment must be installed in an environment where normally only non-conductive pollution occurs but where occasional, temporary conductivity caused by condensation can be expected (as determined according to International Standard EN/IEC 61010-1, Second Edition).

2.1.4 Seismic Anchorage System

A seismic anchorage system (based on California requirements) is available for high-risk seismic zones.

2.2 Installation Checklist

After installing the glassware washer according to the *Uncrating/Installation Instructions* (P122996-649), complete the following checklist to help ensure complete and correct installation, or contact STERIS to schedule a service technician to test your installation and demonstrate proper equipment operation.

- Shutoff valves (not provided by STERIS) capable of being locked in OFF position only for maintenance purposes, installed on steam, air and water lines, and in compliance with local occupational health and safety regulations, as well as electric and plumbing codes for any special requirements that may pertain to installation of this glassware washer.
- Disconnect switches (not provided by STERIS) capable of being locked in OFF position only, installed in electrical supply lines near the glassware washer and in compliance with local occupational health and safety regulations, as well as electric and plumbing codes for any special requirements that may pertain to installation of this glassware washer.

NOTE: *If unit is installed next to other equipment, shutoff valves and disconnect switches should be located so service can be shut off to one piece of equipment at a time.*

- ❑ Glassware washer is positioned, as shown on equipment drawing (122992-953 for Reliance 400 or 122993-554 for Reliance 500), with required clearance space and in relation to building supply lines.
- ❑ Glassware washer is level. Use leveling legs, if necessary.
- ❑ If glassware washer is equipped with cold water pre-wash, drain discharge cooldown or non-vented vapor condenser option, building cold water line supplies water to glassware washer as specified on equipment drawing.
- ❑ Building hot water line supplies water to glassware washer as specified on equipment drawing.
- ❑ If glassware washer is steam-heated, building steam line provides steam to glassware washer as specified on equipment drawing.
- ❑ If glassware washer is steam-heated, building condensate return line is connected to glassware washer as specified on equipment drawing.
- ❑ Pure water line supplies water to glassware washer as specified on equipment drawing.
- ❑ Building air line supplies air to glassware washer as specified on equipment drawing.
- ❑ Building waste line is connected to glassware washer as specified on equipment drawing.
- ❑ If vented glassware washer, building ventilation system is connected to glassware washer as specified on equipment drawing.
- ❑ Electrical supply for glassware washer is as specified on equipment drawing.
- ❑ Pressure for air, water and steam (if option applies) supplies is within range specified on equipment drawing.
- ❑ Chemical injection pumps are connected to proper chemical injection lines and each chemical suction tube and float are placed in proper container.
- ❑ Chemical squeeze tubes have been lubricated.
- ❑ Floor underneath glassware washer has a noncombustible and nonslip surface or is covered with a metal sheet extending to the outer edges of the glassware washer.
- ❑ Walls surrounding glassware washer have a noncombustible surface.

 **WARNING – POSSIBLE FIRE HAZARD:** When glassware washer is installed on a combustible floor, floor must be covered with a metal sheet extending to the outer edges of glassware washer.

IMPORTANT: After a few weeks of operation, inspect unit for leaks. Retighten all clamps and connections.

2.3 Detergents and Chemical Additives Specifications

Selection of chemical additives is open to customer preference, however, to achieve optimal performance, selected chemical additives must meet as a minimum the following specifications:

Product Description	Dilution Range (oz. /gallon) [mL/L]	pH Range Use-Dilution	Other Applicable Requirements
Alkaline Detergents	1/4 - 2 [2 - 16]	9.0 -12.0	Liquid, non-foaming, high-chelating ability, free rinsing.
Acidic Detergents	1/4 - 2 [2 - 16]	3.0 - 6.0	Liquid, non-foaming, high-chelating ability, free rinsing.
Neutral Detergents	1/4 - 2 [2 - 16]	6.0 - 8.0	Liquid, non-foaming, high-chelating ability, free rinsing.
Descalers	2 [16]	< 2.5	Liquid, non-foaming, phosphoric acid based, free-rinsing.

NOTE: For cleaning and descaling products, note the following:

- 1) *Always use a non-foaming detergent for effective cleaning and proper pump operation.*
- 2) *Follow detergent manufacturer's recommendations to determine the temperature of the Wash treatment. Refer to **Table 5-1**, Cycle Description Chart, for available temperature ranges.*
- 3) *Follow detergent manufacturer's recommendations for amount of detergent to use depending on water hardness.*
- 4) *Contact STERIS for information on specific cleaning and descaling products recommended for use with this equipment.*

To achieve maximum cleaning efficiency, select appropriate chemical cleaner to soil type being processed. STERIS recommends the following products:

- **Glass-Klenz[®] Glassware Detergent** is a blend of selected cleaning and water conditioning agents for the cleaning of laboratory glassware and glass components in pharmaceutical and cosmetic manufacturing facilities and animal biotech research areas. Its effective detergent system operates on a wide range of organic and inorganic soils, while water conditioning agents virtually eliminate spots in even problem water areas.
- **CIP 100[®] Alkaline Process and Research Cleaner** is a liquid, alkaline detergent system specially formulated to meet the unique cleaning demands found in pharmaceutical, cosmetic, medical device and food and beverage industries. It effectively removes a wide range of process residues, from fermentation by-products to silicone-based emulsions and lubricants.
- **CIP 200[®] Acid-Based Process and Research Cleaner** is a liquid, acidic detergent system specially formulated to meet the unique cleaning demands found in pharmaceutical, cosmetic, medical device and food and beverage industries. It effectively removes a wide range of process residues, from inorganic salts to particulate carbon.
- **CIP 220[®] Acid-Based Process and Research Cleaner** is a liquid, hydroacetic acid-based detergent system specially formulated to meet the unique cleaning demands found in pharmaceutical, cosmetic, medical device and food and beverage industries. Phosphate-free, it effectively removes a wide range of process residues, from inorganic salts to particulate carbon.

NOTE: Certain products may not be available in your area. Contact STERIS for product availability and ordering information.

IMPORTANT: *STERIS does not promote, recommend or endorse the use of any other type of chemical additives in the processing of articles in this washer, such as drying agents, strong alkaline detergents (pH>12), alcohol rinses and liquid germicides including hypochloric acid (bleach).*

COMPONENT IDENTIFICATION

! IMPORTANT: A listing of the Safety Precautions to be observed when operating and servicing this glassware washer can be found in SECTION 1 of this manual. Do not operate the equipment until you have become familiar with this information.

3.1 Before Operating Glassware Washer

The Reliance® 400 Laboratory Glassware Washer and Reliance® 500 Laboratory Glassware Washer are equipped with a fully-programmable microprocessor control system capable of storing up to 10 cycles for processing a wide variety of loads. Control system monitors and automatically controls all cycle operations and functions.

Before operating either glassware washer, it is important to become familiar with the locations and functions of all major components and controls (see Figures 3-1 and 3-2).

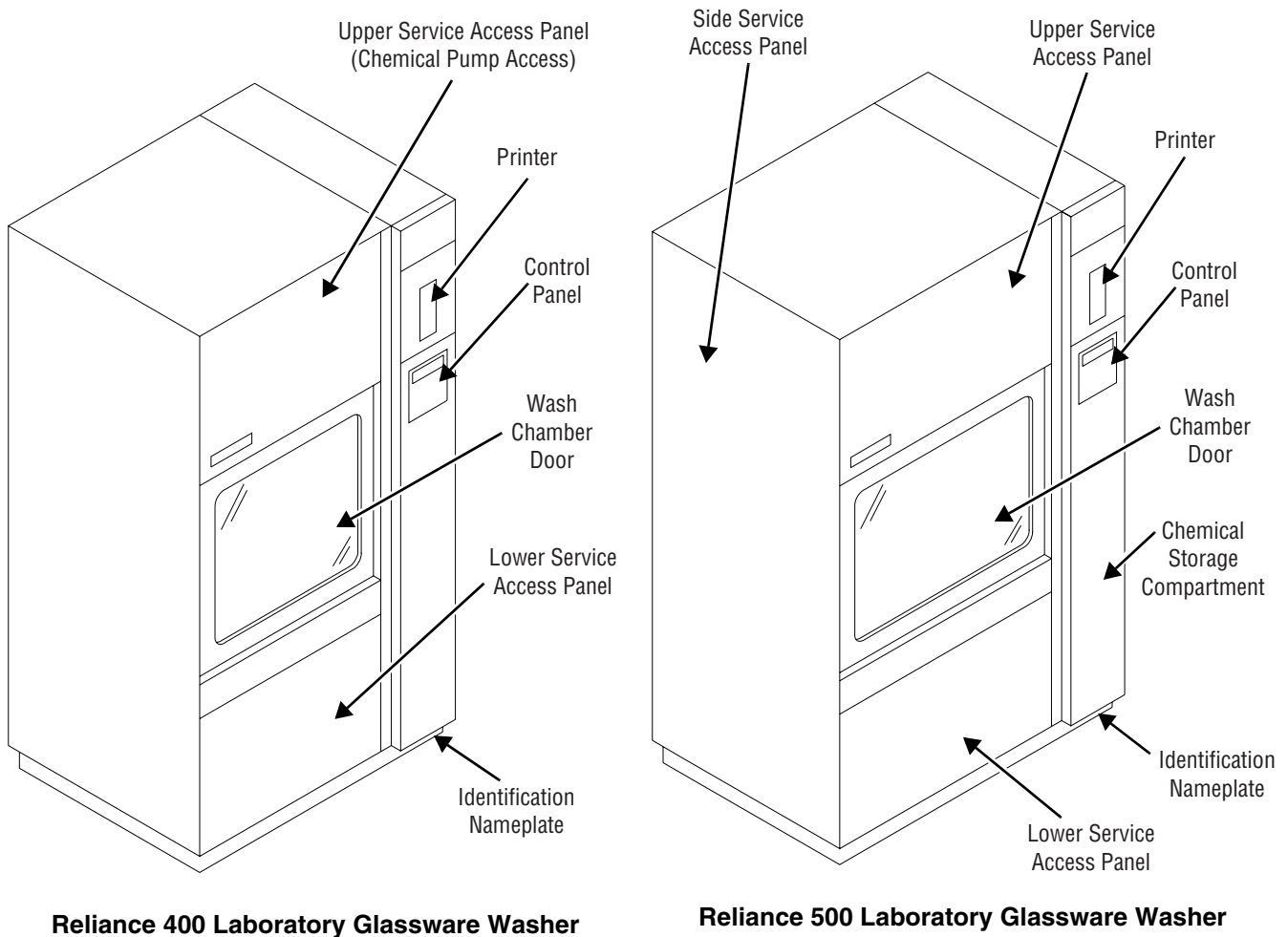
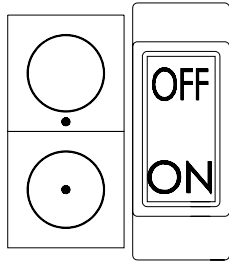

Figure 3-1. Component Identification

3.2 Control Location

3.2.1 Power Switch



The **Power** switch – used to shut off power to the unit control board and I/O board for maintenance purposes. **Power** switch is located under load side control (see Figure 3-2).

IMPORTANT: *Power switch should remain in the ON position at all times for normal unit operation.*

3.2.2 POWER-OFF/STANDBY Switch

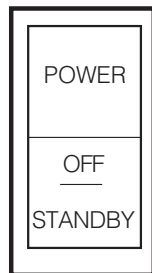

The **POWER-OFF/STANDBY** switch, located behind the printer door, includes two settings which direct operation of the control (see Figure 3-2).

- **POWER** – press top portion of rocker switch to initialize controls and place control in Automatic mode. If option applies, pure water tank fills and begins heating water.
- **OFF/STANDBY** – press bottom portion of rocker switch to initiate SHUTDOWN cycle and turn off all ac power to control (Standby mode).

NOTE: *Control should be placed in Standby mode after last cycle of the day and when glassware washer is not in use for an extended period of time.*

IMPORTANT: *Placing POWER-OFF/STANDBY switch to OFF/STANDBY position DOES NOT turn off electrical power to the unit.*

3.2.3 Printer

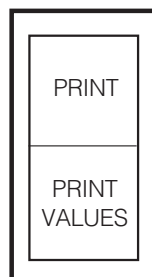

The printer records all cycle data on 2-1/4 inch wide, single-ply, thermal paper. Refer to **SECTION 6, ROUTINE MAINTENANCE**, for paper changing and paper ordering information.

The printer is located inside of load side control panel, to the right of load door.

Printer Function switch – Controls two printer functions, **PRINT** and **PRINT VALUES**:

- **PRINT** – pressing top portion of rocker switch generates a complete printout of current water temperature of sump and optional pure water tank, and air temperature in drying chamber.
- **PRINT VALUES** – pressing bottom portion of rocker switch generates a complete printout of all cycle values.

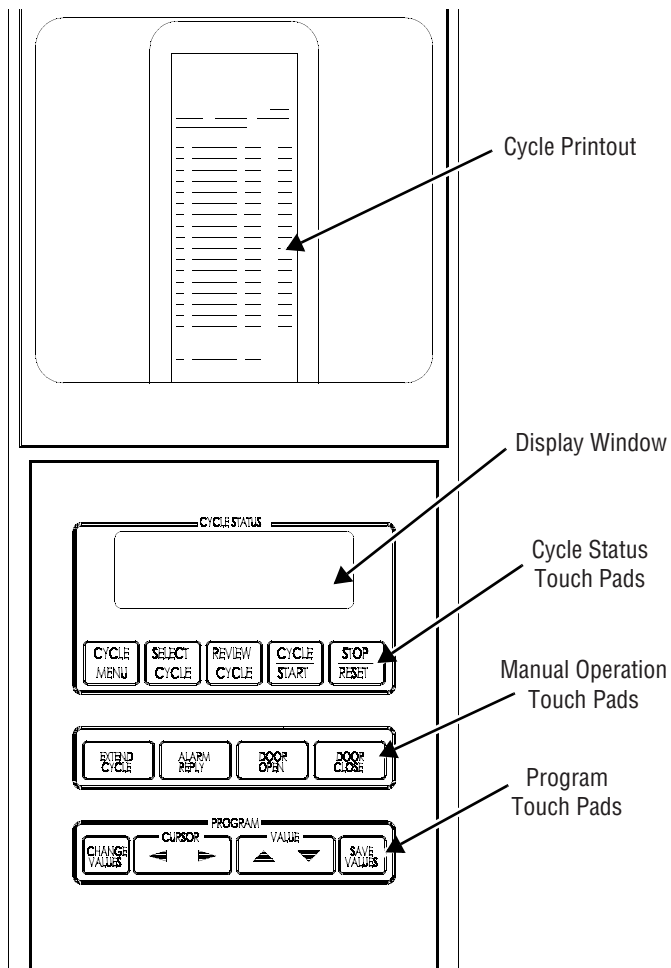

FRONT CONTROL PANEL

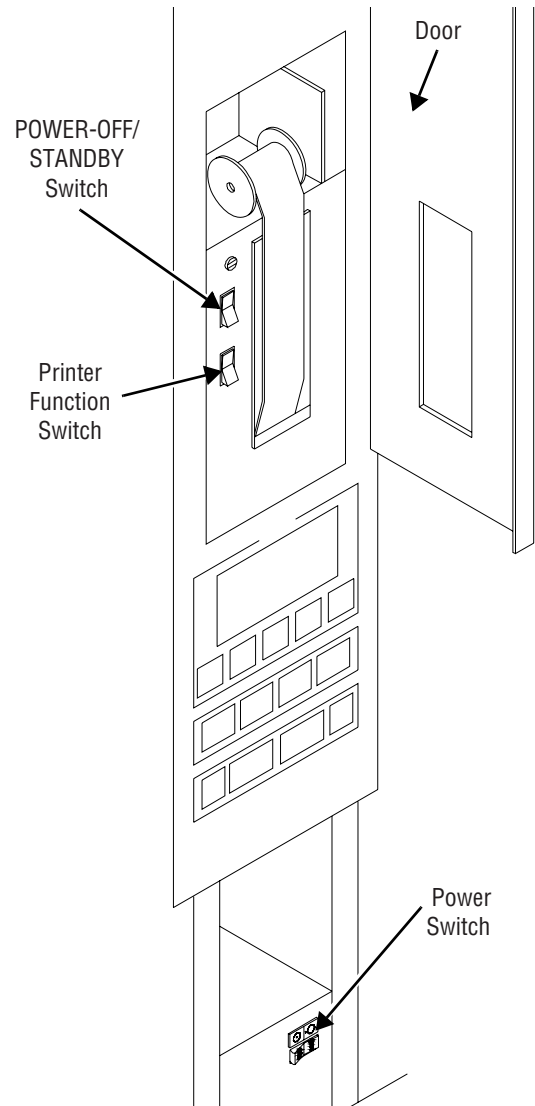

LOAD SIDE CONTROL AND PRINTER

NOTE: On double-door units, control panel is located on both load and unload sides of equipment. Printer is located on load side only.

Figure 3-2. Printer and Front Control Panel

3.3 Load Side Control Panel

The load side control panel is used to direct all washer functions. The operator may select and review cycles and treatments, start, stop or reset cycle operation and monitor cycle performance and washer status from the control panel.

Standard load side control panel includes a printer.

3.3.1 Display Screen

The two-line, alphanumeric screen displays cycle program data on demand, in-cycle performance data and operator instructions. Display screen also indicates certain abnormal conditions that may occur during a cycle (see Figure 3-2).

3.3.2 Touch Pads

Cycle Status Touch Pads (see Figure 3-2):



CYCLE MENU touch pad – press to view Cycle menus. Three Cycle menus are available.



SELECT CYCLE touch pad – press to select one of the four cycles available from each Cycle menu.

NOTE: When a displayed cycle or treatment value is selected, corresponding word or digit flashes.



REVIEW CYCLE touch pad – press to review different treatments and values programmed for selected cycle. Only those treatment values that can be modified by operator are displayed. Refer to **SECTION 4, OPERATING INSTRUCTIONS**, for instructions on reviewing cycle values.



CYCLE/START touch pad – press once to display name of selected cycle. Press a second time to start the cycle. Refer to **SECTION 4, OPERATING INSTRUCTIONS**, for instructions on running a cycle.

*NOTE: Selected cycle name remains on screen for five seconds after pressing **CYCLE/START** touch pad once. To start a cycle, **CYCLE/START** touch pad must be pressed a second time while the selected cycle name is displayed. If touch pad is not pressed within the five seconds, screen automatically returns to Cycle menu.*



STOP/RESET touch pad – press once to stop operation of a cycle. Press a second time to abort cycle operation. Refer to **SECTION 4, OPERATING INSTRUCTIONS**, for instructions on how to stop and abort cycle operation.

*NOTE: When cycle is stopped, press **CYCLE/START** touch pad once to resume cycle operation. Cycle operation resumes at the point where treatment was interrupted. When cycle is aborted, cycle operation is discontinued and cycle must be restarted from the beginning of the cycle.*

Manual Operation Touch Pads:



EXTEND CYCLE touch pad – press to double programmed treatment time while reviewing a cycle in Review Cycle mode. Refer to **SECTION 4, OPERATING INSTRUCTIONS**, for instructions on extending treatment time.



ALARM REPLY touch pad – press to stop intermittent alarm buzzer and acknowledge the displayed alarm message. Refer to **SECTION 4.7, ACKNOWLEDGE ALARM CONDITION**, for instructions on acknowledging alarms and **SECTION 7, TROUBLESHOOTING**, for specific alarm conditions and corrective actions.



DOOR OPEN touch pad – press to automatically raise door to open position.



DOOR CLOSE touch pad – press to automatically lower door to closed position.

Program Touch Pads:



CHANGE VALUES touch pad – press to modify, add, create or remove treatments from programmed cycles. Refer to **SECTION 5, CYCLE AND CONTROL VALUE PROGRAMMING**, for instructions on changing cycle values.



CURSOR arrows (left or right) – press to move left or right on display screen.



VALUE arrows (up or down) – press to move up or down on display screen and, depending on selected item, press to either toggle between answer selections or scroll through alphabet and numbers 0 through 9.

NOTE: *Alphabet includes characters for an underline and a space (■).*



SAVE VALUES touch pad – press to permanently store all treatment value and cycle changes in control memory.

3.4 Unload Side Control Panel

The unload side control panel features same touch pads and display as load side control panel. Display window concurrently shows same message as shown in display window on operating side of the unit.

Standard unload side control panel does not include a printer.

IMPORTANT: A listing of the Safety Precautions to be observed when operating and servicing this glass-ware washer can be found in SECTION 1 of this manual. Do not operate the equipment until you have become familiar with this information.

4.1 Before Operating Equipment



WARNING – BURN HAZARD:

- Except for an emergency, do not open door when cycle is in progress. In an emergency, first stop cycle by pressing STOP/RESET touch pad and wait for water flow to stop. Wear appropriate Personal Protective Equipment (PPE) whenever reaching into chamber.
- After pressing STOP/RESET touch pad, wait until water flow stops before slowly opening door. Hot water/steam may be sprayed through door opening if door is opened too soon.



WARNING—SLIPPING HAZARD: To prevent slips, keep floors dry. Promptly clean up any spills or drippage. For spills or drippage of detergents or other chemicals, follow safety precautions and handling procedures set forth on detergent or chemical label and/or Material Safety Data Sheet (MSDS).

Refer to SECTION 5, CYCLE AND CONTROL VALUE PROGRAMMING, to change cycles, cycle values or control values.

1. Verify building electrical disconnect switch (circuit breaker) is positioned to **ON**.
2. Verify unit supply valves are open.
3. Ensure power switch (located under load side control and printer) is in **ON** position (refer to Figure 3-2).
4. Put **POWER-OFF/STANDBY** switch (located behind control door) to **POWER** position.
5. Open chamber door.
6. Verify wash chamber is empty and all packing material has been removed.
7. Verify debris screens in chamber are clean and in place.
8. Open printer door and ensure sufficient amount of printer paper is available.

NOTE: When verifying printer paper, note the following:

- 1) A color warning stripe is visible when paper roll is near the end. Refer to SECTION 6.9, CHANGING PRINTER PAPER ROLL, if paper roll needs to be replaced.
 - 2) Do not operate printer without paper.
9. Verify chemical supply at a remote location (up to 8 ft [2.40 m] off ground and 50 ft [15.3 m] from washer). Ensure suction tube(s) and low level sensor are placed in container(s) (see Figure 4-1).

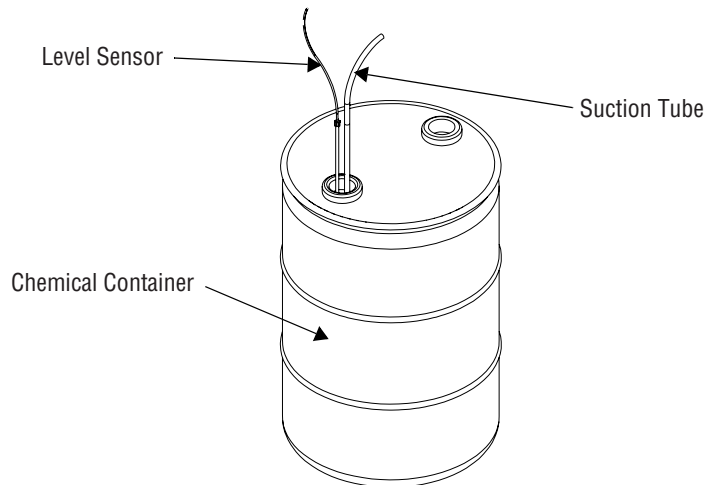

Figure 4-1. Chemical Container



CAUTION – POSSIBLE EQUIPMENT DAMAGE:

- Always position each manifold and/or bottom rotary spray over a manifold connector before operating unit. If manifolds and/or bottom rotary sprays are not positioned correctly, damage will result and unit will be unable to effectively wash load.
- When choosing a detergent, select one with a low-chloride content. Detergents with a high-chloride content must not be used, as such detergents may harm stainless steel.

4.2 Priming Procedure



WARNING – CHEMICAL BURN AND/OR EYE INJURY HAZARD: Detergents are caustic and can cause adverse effects to exposed tissues. Do not get in eyes, on skin or attempt to swallow. Read and follow the precautions and instructions on the detergent label and in the Material Safety Data Sheet (MSDS) prior to handling the detergent, refilling the detergent container or servicing the detergent injection pump and lines. Wear appropriate Personal Protective Equipment (PPE) whenever handling the detergent or servicing the detergent injection pump and lines.

If supply is low or has run out, install new container and prime associated chemical pump. Refer to *SECTION 6.6, CHEMICAL CONTAINER REPLACEMENT*, for detergent container replacement instructions and to *SECTION 4.2, PRIMING PROCEDURE*, for priming procedure.

IMPORTANT: DO NOT insert suction tube into container without verifying it is for the proper application (refer to *SECTION 2.3, DETERGENTS AND CHEMICAL ADDITIVES SPECIFICATIONS*, for details).

10. To achieve maximum cleaning efficiency, select detergents appropriate to soil type being processed.

NOTE: For cleaning and descaling products, note the following:

- 1) Always use a non-foaming detergent for effective cleaning and proper pump and water-level operation.
- 2) Refer to Detergent Specifications in *SECTION 2.3, DETERGENTS AND CHEMICAL ADDITIVES SPECIFICATIONS*, and follow detergent manufacturer's recommendations to determine the temperature of the Wash treatment. Refer to **Table 5-1, Cycle Description Chart**, for available temperature ranges.
- 3) Follow detergent manufacturer's recommendations for amount of detergent to use depending on water hardness.
- 4) Contact **STERIS** for information on specific cleaning and descaling products recommended for use with this equipment.

1. Open chamber access door.
2. Press **CYCLE MENU** touch pad to scroll to third Cycle menu.
3. Press **SELECT CYCLE** touch pad to select PRIME:

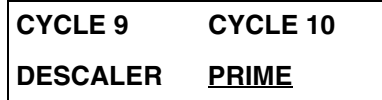

— indicates flashing position

4. Press **CYCLE/START** touch pad to start priming. Display shows:

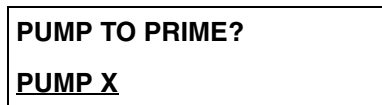

— indicates flashing position

5. Scroll through pump names, using **VALUE arrows** (up or down) until pump to be primed is displayed.
6. Press **CYCLE/START** touch pad to confirm pump selection. Display shows:





7. Press **CYCLE/START** touch pad and hold for 30 to 60 seconds until a few drops of detergent come out of detergent injector (located inside wash chamber, behind lower right hand corner of load side door).
8. Release **CYCLE/START** touch pad to stop priming operation.
9. Press **STOP/RESET** touch pad when priming is complete.



4.3 Accessories

STERIS provides a complete line of accessories for use with this equipment. Contact STERIS for more information on these products.

IMPORTANT: *Maximum loading weight (accessory and accessory contents) inside glassware washer is 200 lb (91 kg).*

To properly clean items and to avoid personal injuries, always follow these general loading guidelines:

- Ensure no items stick out or hang out of the rack. Always use a rack designed to handle the appropriate type of items to be processed.
- Glassware must always be placed in a spindle header for processing, never alone on a manifold rack.
- Miscellaneous articles can be placed in a general purpose basket with or without a general purpose basket cover.

NOTE: *To avoid personal injuries, baskets and accessories must be loaded on an appropriate loading cart or surface.*

- **Bottom rotary spray headers and rack** (see Figure 4-2): used with general purpose rack, tube rack and petri dish rack to provide load coverage from bottom.

General purpose rack (see Figure 4-2) – used with bottom rotary spray header to wash beakers and miscellaneous hardware. Beakers must be inverted when loaded in rack.

Test tube rack (see Figure 4-2) – used with bottom rotary spray header, basket, divider and cover to wash test tubes from 3/8 to 1-1/2" (10 to 38 mm) in diameter and/or beakers. Rack holds six test tube baskets.

Test tube basket and basket divider (see Figure 4-2) – Basket is used with bottom rotary spray header, test tube rack, cover and divider to hold test tubes and small miscellaneous glassware during washing. Basket divider partitions basket into four parts to support smaller or partial loads. Each basket holds approximately 120 test tubes. Test tubes must be inverted when loaded in basket.

Test tube basket cover (see Figure 4-2) – used with test tube basket to hold test tubes in place while inverted in basket.

Petri dish rack (see Figure 4-2) – used with bottom rotary spray header to wash petri dishes. Rack holds up to 55 petri dishes up to 4.0" (102 mm) in diameter by 5/8" (16 mm) deep.

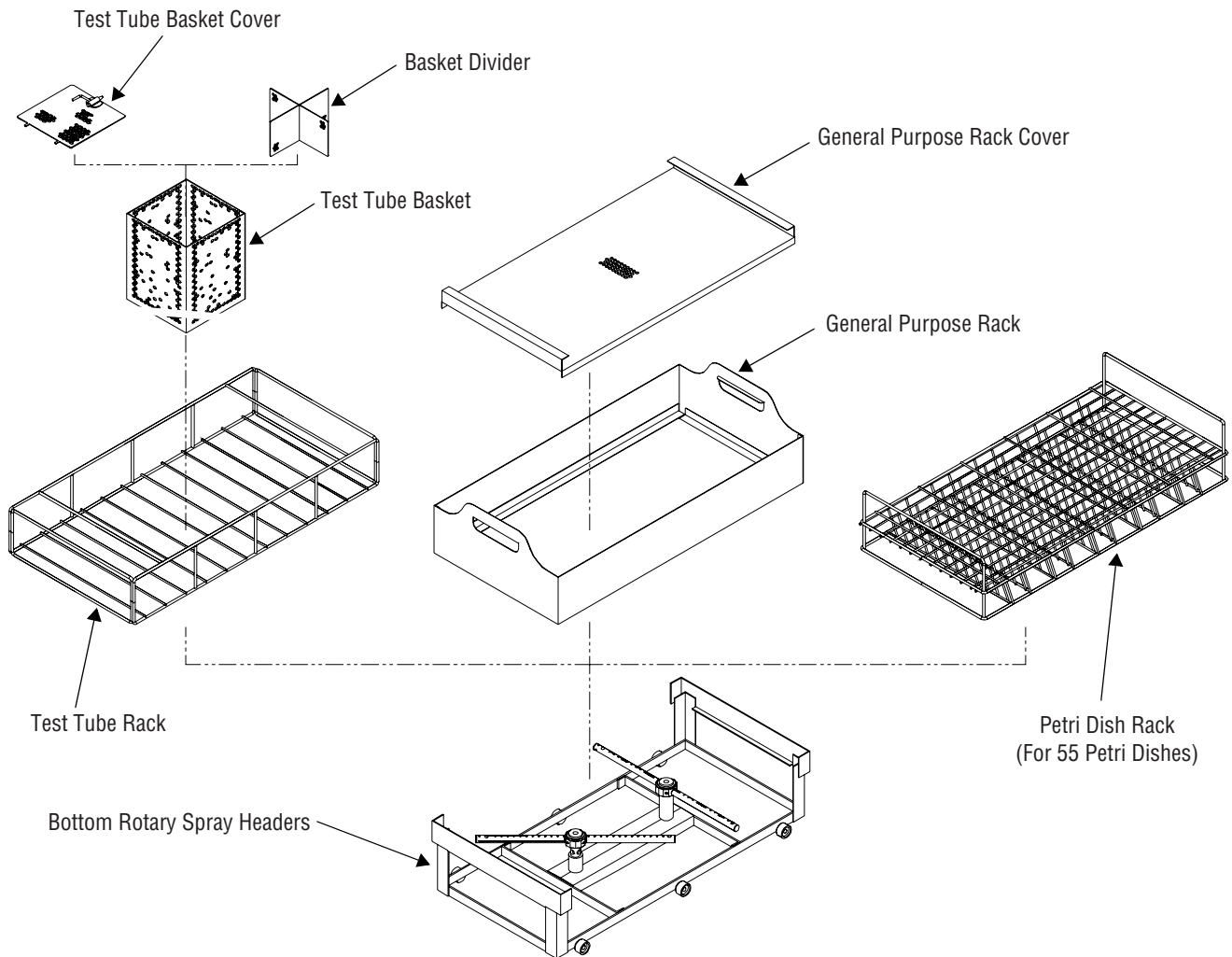

Figure 4-2. Bottom Rotary Spray Headers

- **Glassware support**, supports baskets and spindle headers (see Figure 4-3):

Two-spindle header, used with support basket and glassware support to wash large glassware up to 12" (305 mm) in diameter;

Eight-spindle header, used with support basket and glassware support to wash large glassware up to 5-3/4" (146 mm) in diameter;

18-spindle header, used to wash glassware up to 250 mL;

32-spindle header, used to wash glassware up to 200 mL;

50-spindle header, used to wash glassware up to 100 mL;

72-spindle header, used to wash glassware up to 50 mL;

98-spindle header, used to wash small glassware.

- **Pipette header** (see Figure 4-4): used to individually wash all types of pipettes, from 1/10 to 25 mL.

Flooded system pipette header – used to wash straight-sided pipettes of mixed sizes and lengths, up to 17" (432 mm) long. Maximum capacity is 575 one-mL pipettes. A longer wash time is recommended. **Only one** flooded system pipette header can be used at a time, and the optional loading shelves cannot be used.

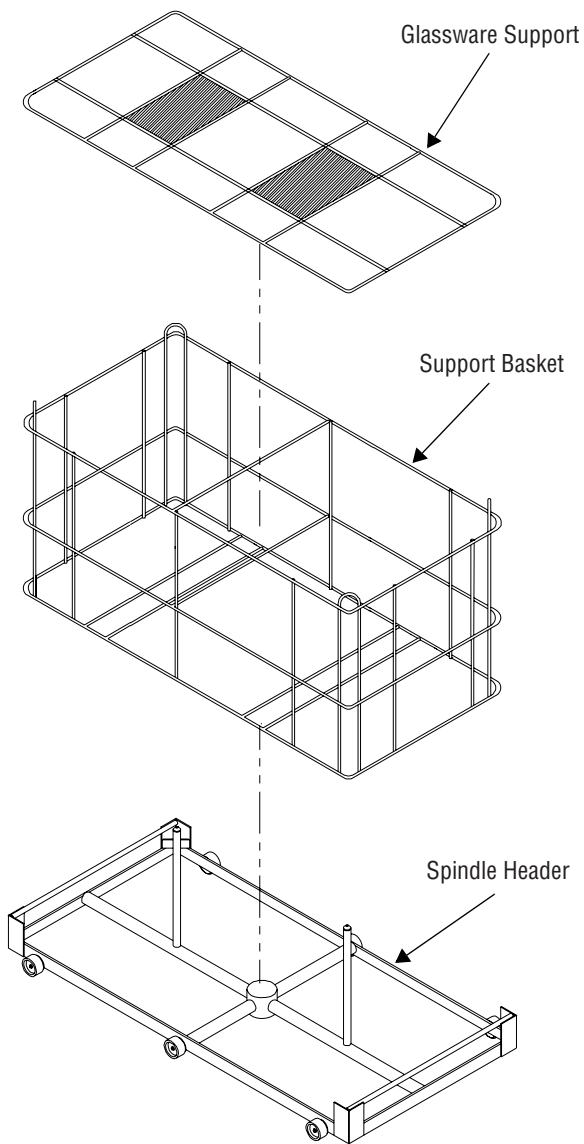

Figure 4-3. Glassware Support

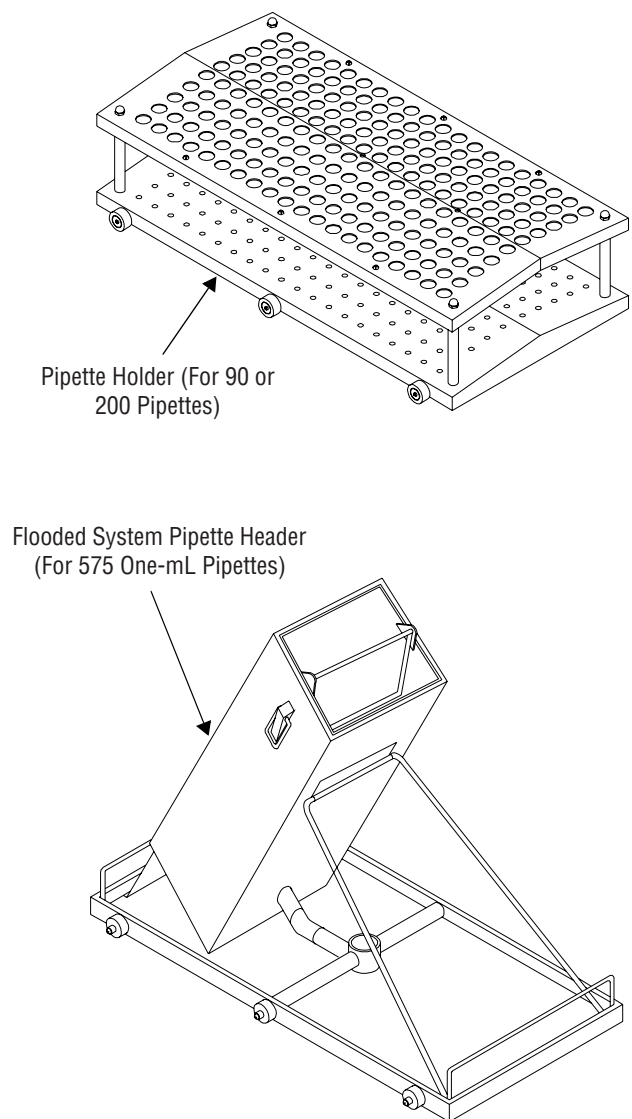



Figure 4-4. Pipette Header

- **Transfer cart** – for loading accessory headers into and out of washer.
- **Universal transfer cart** – Height-adjustable for transferring accessories into and out of washer.

4.4 Loading Glassware Washer

 **WARNING—PERSONAL INJURY AND/OR EQUIPMENT DAMAGE HAZARD:** Always load baskets on appropriate loading cart or surface.

DOOR OPEN

DOOR CLOSE

4.4.1 Universal Shelving System (Optional)

 **CAUTION – POSSIBLE EQUIPMENT DAMAGE:** Always position each accessory header over a manifold connector before operating unit. If accessory headers are not positioned correctly, damage may result and unit will be unable to effectively wash load.

4.4.2 Universal Shelving System (Optional) – Reliance 400

NOTE: To avoid personal injuries, baskets and accessories must be loaded on appropriate loading cart or surface.

1. Use a transfer cart to bring fully loaded basket or rack to washer.

IMPORTANT: Maximum loading weight (accessory and accessory contents) inside glassware washer is 200 lb (91 kg).
2. Ensure all items are correctly positioned on rack and/or basket.
 - a. When loading a rack or basket, beakers must be placed open end down.
 - b. If lightweight plasticware or metalware is being washed, use a cover to prevent items from turning.
3. Press **DOOR OPEN** touch pad to open load chamber door and slide loaded accessory headers into wash chamber. Verify each header is positioned directly over a manifold connector.
4. Press **DOOR CLOSE** touch pad to close load chamber door.

Universal shelving system allows processing of loads of different sizes by removing shelf sections. For the Reliance® 400 Laboratory Glassware Washer, it is possible to remove the right section; for the Reliance® 500 Laboratory Glassware Washer, it is possible to remove the central section only or the central and right sections (see Figures 4-5 to 4-7).

NOTE: Universal shelving system can only be removed and replaced from load side of the washer.

IMPORTANT: When removing sections from universal shelving system, unload wash chamber to avoid damaging glassware.

Universal shelving system (see Figure 4-6).

Remove right section from shelving system to process loads more than 10-1/2" (260 mm) high and up to 25-1/2" (650 mm) high:

1. Press on right latch under shelf section to unlock.
2. Put a hand under shelf section spray arm as a support and with other hand, slide section out from wash chamber.

To reinstall shelf section:

1. Slide flaps on both sides of support into shelf sliding guides. Ensure manifold connector simultaneously fits into position.
2. Push shelf section to end of chamber and push on right latch to lock it in place.

NOTE: Use appropriate support basket and glassware support to process larger loads when removing a shelf section.



**Figure 4-5. Universal Shelving System
(Reliance 500 Shown)**

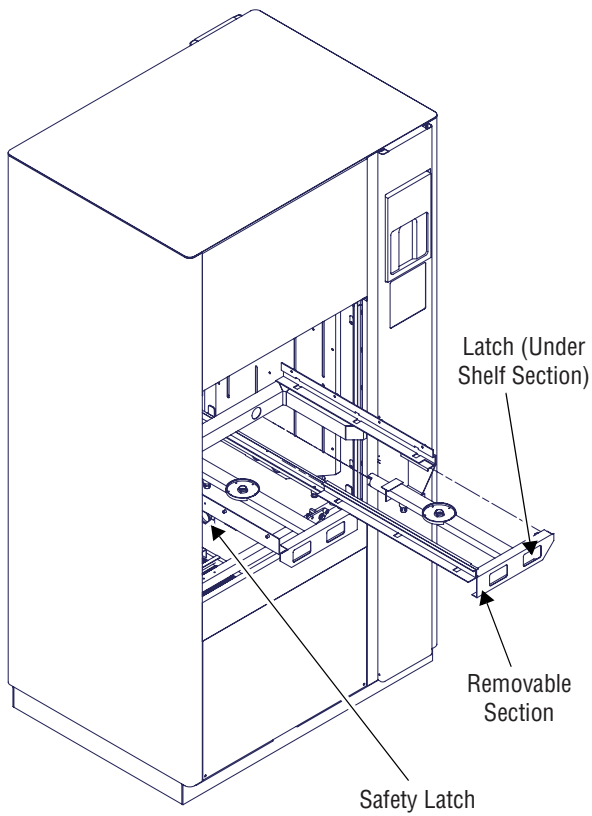

**Figure 4-6. Universal Shelving System –
Reliance 400**

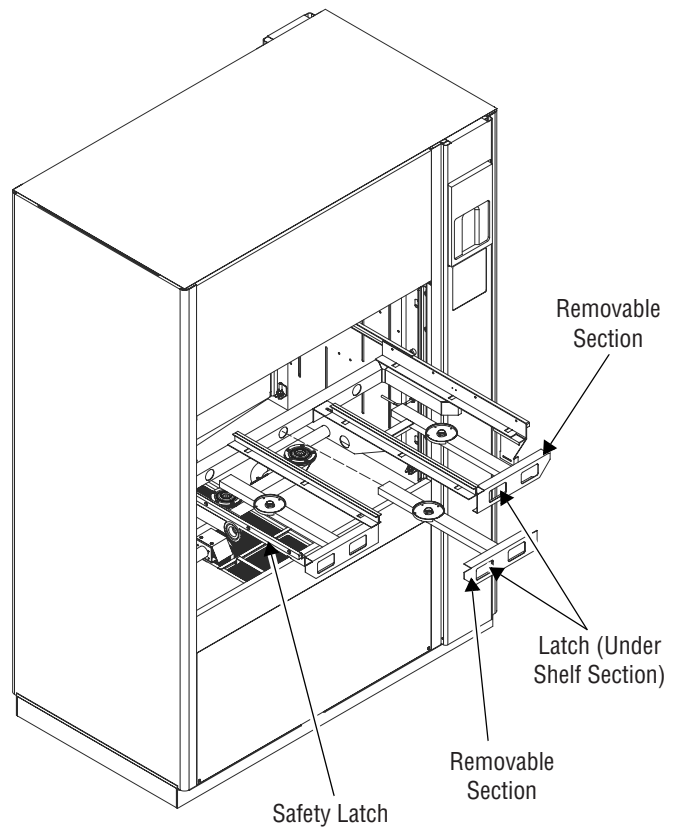

**Figure 4-7. Universal Shelving System –
Reliance 500**

4.4.3 Universal Shelving System (Optional) – Reliance 500

Universal shelving system (See Figure 4-7).

It is possible to remove central section only to accommodate two loads of small items of glassware on each side (up to 10-1/2" [260 mm] high) and a load of larger items (more than 10-1/2" [260 mm] high and up to 25-1/2" [650 mm] high) in the center (see Figure 4-5).

If a greater loading space is required for larger loads, it is possible to remove central and right sections.

NOTE: Load must not exceed 25-1/2" (260 mm) high.

To remove central section from universal shelving system (see Figure 4-7):

1. Press on latch located under central shelf section right corner to unlock.
2. Put a hand under shelf section spray arm to support and with other hand, slide section out from wash chamber.

To reinstall central section:

1. Insert flaps on both sides of support into shelf sliding guides. Ensure manifold connector simultaneously fits into position.
2. Push shelf section to end of chamber and push on right latch to lock it in place.

To remove right section from universal shelving system:

1. Press on latch located under right shelf section right corner to unlock.
2. Put a hand under shelf section spray arm to support and with other hand, slide section out from wash chamber.

To reinstall right section:

1. Insert flap from support into shelf sliding guide. Ensure manifold connector simultaneously enters into its position.
2. Push shelf to end of chamber and push on right latch to lock it in place.

NOTE: For the universal shelving system, note the following:

- 1) *Use appropriate support basket and glassware support to process larger loads when removing shelf sections.*
- 2) **Reliance 500 only:** *Reinstall right section first on universal shelving system before reinstalling central section.*
- 3) *Remove shelf sections before removing entire universal shelving system from unit.*

To remove entire universal shelving system:

1. To remove entire universal shelving system, press safety latch on left side of shelf, and slide shelf out of wash chamber (see Figures 4-6 and 4-7).
2. To replace universal shelving system, align shelf with chamber guides and push shelf into chamber until safety latch locks in place.

4.5 Typical Cycle Operation



WARNING – BURN HAZARD:

- Except for an emergency, do not open door when cycle is in progress. In an emergency, first stop cycle by pressing **STOP/RESET** touch pad and wait for water flow to stop. Wear appropriate Personal Protective Equipment (PPE) whenever reaching into chamber.
- After pressing **STOP/RESET** touch pad, wait until water flow stops before slowly opening door. Hot water/steam may be sprayed through door opening if door is opened too soon.



WARNING–PERSONAL INJURY HAZARD: In case of power loss, power door(s) lowers slowly by gravity. Keep hands and items out of door area to avoid personal injury.



CAUTION – POSSIBLE EQUIPMENT DAMAGE:

- Always position each manifold and/or bottom rotary spray over a manifold connector before operating unit. If manifolds and/or bottom rotary sprays are not positioned correctly, damage will result and unit will be unable to effectively wash load.
- Always select a cycle appropriate for the items being processed. Failure to do so may result in product damage.

Both Glassware Washers are equipped with an Eagle® 3000 Stage 3 Control System, which offers a wide variety of treatment combinations resulting in a large number of possible cycle types.

NOTE: For typical cycle operation, note the following:

- 1) Washer operation can be halted at any time by pressing **STOP/RESET** touch pad. Pressing **STOP/RESET** touch pad once halts cycle and printout message says "STOP PRESSED!" Pressing **STOP/RESET** touch pad twice aborts cycle and printout message is "CYCLE ABORTED!" To resume cycle, press **CYCLE/START** touch pad. In an emergency, if it is necessary to open door after pressing **STOP/RESET** touch pad, wait for water flow to stop and then open door. To resume cycle, close door and press **CYCLE/START** touch pad.
- 2) Review SECTION 7, TROUBLESHOOTING, to identify the cause of any abnormal condition during a cycle, or if unit fails to complete a cycle.

The following cycle description applies to the **preprogrammed LIGHT cycle**, which is the most extensive combination of pre-programmed treatments. Refer to **Table 5-1, Cycle Description Chart**, for default treatment values of the LIGHT cycle.

1. Ensure power switch (located under load side control) is positioned to **ON** (refer to Figures 3-1 and 3-2).
2. Position **POWER-OFF/STANDBY** switch (located behind printer door) to **POWER** position. Display shows, for example:

RELIANCE MODEL 400

then:

<u>LIGHT</u>	MEDIUM
HEAVY	CYCLE 4

— indicates flashing position

and printout message is:

```

* CONTROL ON      7:08:24A
                  94/03/09
*****
RELIANCE
MODEL 400
S/N 0000000000
*****

```

3. Press **CYCLE MENU** touch pad to scroll between three Cycle menus. Press **SELECT CYCLE** touch pad to select a cycle from displayed menu (cycle is flashing).



4. Press **CYCLE/START** touch pad to select cycle. Name of selected cycle appears and remains displayed for a few seconds:

**PRESS START TO
PROCESS - LIGHT**

— indicates flashing position



5. Press **CYCLE/START** touch pad a second time while cycle name is displayed.

NOTE: If **CYCLE/START** touch pad is not pressed a second time while selected cycle name is displayed, screen automatically returns to Cycle menu.

Once cycle is started, printer records:

```
=====
                        CYCLE - LIGHT
=====
```

```
CYCLE START      8:10:58A
CYCLE DATE       94/03/09
CYCLE NUMBER     0000001
UNIT NUMBER      0000000000
MOTOR SPEED =    LOW
```

NOTE: Programmed pump speed is **LOW** for **Reliance 400** and **Reliance 500** without universal shelving system. Programmed pump speed is **HIGH** for **Reliance 400** or **Reliance 500** with universal shelving system.

6. Cycle proceeds through selected treatments as follows:

NOTE: For cycle treatments, note the following:

- 1) To extend time of a particular treatment, press **EXTEND CYCLE** touch pad while reviewing cycle selection, using **REVIEW CYCLE** touch pad (see SECTION 4.6, EXTEND CYCLE TREATMENT). This suspends initial time setting and causes time of the treatment in progress to be multiplied by two.
 - 2) Always use a non-foaming detergent for effective cleaning and proper pump and water-level control operation. Detergents with a high chloride content should not be used, as chlorides are harmful to stainless steel. Refer to detergent specifications in SECTION 2.3, DETERGENTS AND CHEMICAL ADDITIVES SPECIFICATIONS.
 - 3) Sump may contain water retained from previous cycle. Refer to SECTION 5, CYCLE AND CONTROL VALUE PROGRAMMING, for information on water save feature.
- **Pre-Wash:** Load is pre-washed with cold water (maximum 60°F [16°C]) from building supply line for one minute (factory-setting). Water is drained.

WARNING—SLIPPING HAZARD: To prevent slips, keep floors dry. Promptly clean up any spills or drippage. For spills or drippage of detergents or other chemicals, follow safety precautions and handling procedures set forth on detergent or chemical label and/or Material Safety Data Sheet (MSDS).

WARNING – CHEMICAL BURN AND/OR EYE INJURY HAZARD: Detergents are caustic and can cause adverse effects to exposed tissues. Do not get in eyes, on skin or attempt to swallow. Read and follow the precautions and instructions on the detergent label and in the Material Safety Data Sheet (MSDS) prior to handling the detergent, refilling the detergent container or servicing the detergent injection pump and lines. Wear appropriate Personal Protective Equipment (PPE) whenever handling the detergent or servicing the detergent injection pump and lines.

- **Wash:** Load is washed with detergent injected with water heated at 150°F (65°C) (factory-setting) for two minutes (factory setting). Water is drained.
- **Rinse 1:** Load is rinsed with hot tap water (minimum 110°F [43°C]) for 15 seconds (factory-setting). Water is drained.
- **Rinse 2:** Load is rinsed with hot tap water (minimum 110°F [43°C]) for 15 seconds (factory-setting). Water is drained.
- **Pure Water Rinse 1:**

For optional pure water tank: Load is rinsed with purified water (minimum 60°F [15°C] from building supply line for 10 seconds, (factory-set, non-recirculated). Water is drained or saved for next wash (refer to **SECTION 5, CYCLE AND CONTROL PROGRAMMING**, for information on water save feature).

NOTE: If 10 seconds (factory-set) rinse time is increased from 00:00 to 15:00, Pure Water Rinse treatment is recirculated.

For standard feature: Load is rinsed with purified water heated in the sump at 180°F (82°C) for one minute (factory-set, recirculated; refer to **Table 5-1, Cycle Description Chart**).

- **Drying (option):** Load is dried at 240°F (116°C) setpoint for 15 minutes and one minute cooling by exhaust fan (factory-setting, can be adjusted in Automatic mode).
7. When cycle is complete, buzzer sounds and display shows:

<p>PLEASE OPEN DOOR AND REMOVE THE LOAD</p>
--



8. Press **DOOR OPEN** touch pad to open door. Leave door open to allow load to cool before removing accessory and/or baskets.



9. Press **DOOR CLOSE** touch pad to close door. Display returns to main Cycle menu:

<u>LIGHT</u>	MEDIUM
HEAVY	CYCLE 4

___ indicates flashing position

NOTE: When cycle is complete, door must be opened and then closed before another cycle may be started.

10. Following is an example of sequence of displays that appear on screen while a cycle is in progress:

Printer records start time of treatment:

WASH 1 7:21:33A

and display shows:

LIGHT	150.0F
PUMP1	WASH1

alternating with:

LIGHT	150.0F
FILL/INJ	TIME = 04:00

NOTE: For cycle treatments, note the following:

- 1) *Time displayed on screen counts down remaining time for treatment in progress. During Final Rinse treatment, count-down starts only when temperature setpoint is reached.*
- 2) *If addition of a powder detergent is programmed for a specific treatment, powder detergent must be added to sump at beginning of the treatment. Washer operation automatically stops **before** filling phase, alarm buzzer sounds and display shows: **OPEN LOAD DOOR AND ADD POWDER**. Operator must press **ALARM REPLY** touch pad, open chamber door and add recommended quantity of powder detergent. To resume cycle operation, close door and press **CYCLE/START** touch pad.*

then display shows:

LIGHT	150.0F
PUMP1	WASH1

alternating with:

LIGHT	150.0F
CIRCULATE	TIME = 01:00

then display shows:

LIGHT	150.0F
PUMP1	WASH1

alternating with:

LIGHT	150.0F
DRAINING	TIME = 00:45

4.6 Extend Cycle Treatment



Treatment times may be temporarily extended by pressing **EXTEND CYCLE** touch pad prior to initiating a cycle during cycle program review. Temporarily extended treatment times apply only to immediate selected cycle. On completion of cycle, treatment times return to programmed settings.

1. Press **CYCLE MENU** touch pad to scroll through Cycle menus and press **SELECT CYCLE** touch pad to select cycle.
2. Press **REVIEW CYCLE** touch pad to access Review mode. Continue to press **REVIEW CYCLE** touch pad to advance screen to desired treatment. Display shows:

RINSE1
RECIRC. TIME = 01:00

*NOTE: Cycle may be started at any point while in Review mode by pressing **CYCLE/START** touch pad.*

3. With correct treatment displayed, press **EXTEND CYCLE** touch pad. Programmed treatment time is temporarily doubled. If **EXTEND CYCLE** touch pad is pressed again, treatment time returns to original programmed setting. Display shows:

RINSE1
RECIRC. EXTD = 02:00

*NOTE: While in Review mode, pressing **EXTEND CYCLE** touch pad only allows operator to double programmed treatment time. If a longer treatment time is desired, programmed setting must be adjusted in Change Values mode prior to starting cycle.*

4. Press **REVIEW CYCLE** touch pad again and repeat procedure for each treatment for which time is to be extended.
5. Press **CYCLE/START** touch pad while in Review mode to initiate cycle. Cycle automatically progresses through each treatment as temporarily adjusted in Review mode.

IMPORTANT: To run cycle with extended treatment times, cycle must be started by pressing **CYCLE/START** touch pad while in Review mode. If operator reaches **PRINT CYCLE VALUES?** display and answers **YES** or **NO** without starting cycle first, control exits Review mode. Display screen returns to the Cycle menu and any adjustments made in Review mode are erased.

NOTE: Printout generated in Review mode lists programmed (not extended) treatment values. Extended treatments are identified on in-cycle printout generated while cycle is in process.

* CONTROL ON	7:08:24A
	94/03/09

RELIANCE	
MODEL 400	
S/N 000000000	

=====	
CYCLE - LIGHT	
=====	
CYCLE START	8:10:58A
CYCLE DATE	99/03/09
CYCLE NUMBER	0000001
UNIT NUMBER	000000000
MOTOR SPEED	= LOW
TREATMENT	TIME

PRE-WASH1	8:10:58A
WASH 1	8:21:33A
RINSE 1	8:24:49A
TREAT. EXTEND	
RINSE 2	8:28:31A
PURE W.1	8:31:57A
DRYING	8:33:32A
COMPLETED AT	8:48:32A
CYCLE TIME	= 0:38:36
=====	
= READY TO UNLOAD =	
=====	
DOOR OPEN	8:51:37A

Extended
 Treatment

Figure 4-8. Printout With Extended Cycle Treatment

4.7 Acknowledge Alarm Condition

If an alarm condition occurs during cycle operation, an alarm buzzer sounds to notify operator. Corresponding alarm message screen appears on display, for example:

**ALARM: SUMP
TOO LONG IN FILL**

alternating with:

**CYCLE STOPPED !
PRESS START TO RESUM**

and printer lists type of alarm and time it occurred:

*ALARM: 3:06:25P
SUMP
TOO LONG IN FILL

NOTE: Review SECTION 7, TROUBLESHOOTING, to identify cause of any abnormal condition during a cycle or if unit fails to complete a cycle.



1. Press **ALARM REPLY** touch pad to silence alarm buzzer and acknowledge displayed alarm message. Printer records time alarm was acknowledged, for example:

ALARM ACKNOWLEDGED
AT 2:55:00P

and display shows:

**ALARM: SUMP
TOO LONG IN FILL**

alternating with:

**CYCLE STOPPED !
PRESS START TO RESUM**



2. Press **CYCLE/START** touch pad to resume cycle operation. Printer prints:

*CYCLE RESUME 3:05:22P
RINSE2 3:06:07P

4.8 Stop Cycle Operation

*NOTE: Washer operation can be halted at any time by pressing **STOP/RESET** touch pad. Pressing **STOP/RESET** touch pad once halts cycle and printout message says "STOP PRESSED!" Pressing **STOP/RESET** touch pad twice aborts cycle and printout message is "CYCLE ABORTED!" To resume cycle, press **CYCLE/START** touch pad. In an emergency, if it is necessary to open door after pressing **STOP/RESET** touch pad, wait for water flow to stop and then open door. To resume cycle, close door and press **CYCLE/START** touch pad.*



1. Press **STOP/RESET** touch pad to immediately halt operation of cycle in progress. Display screen indicates **STOP/RESET** touch pad was pressed:

STOP WAS PRESSED
PRESS START TO RESUM

alternating with:

LIGHT	HOT
RINSE1	

and printer records:

WASH1	2:51:32P
RINSE1	2:54:48P
*STOP PRESSED	2:55:00P



2. Press **CYCLE/START** touch pad to resume cycle operation. Treatment resumes at point where it was interrupted:

LIGHT	HOT
RINSE1	

alternating with:

LIGHT	HOT
DRAINING	TIME = 00:45

and printer records:

*CYCLE RESUME	2:55:22P
RINSE 2	2:56:07P



WARNING – BURN HAZARD:

- Except for an emergency, do not open door when cycle is in progress. In an emergency, first stop cycle by pressing **STOP/RESET** touch pad and wait for water flow to stop. Wear appropriate Personal Protective Equipment (PPE) whenever reaching into chamber.
- After pressing **STOP/RESET** touch pad, wait until water flow stops before slowly opening door. Hot water/steam may be sprayed through door opening if door is opened too soon.

4.9 Abort Cycle Operation



WARNING – BURN HAZARD:

- Except for an emergency, do not open door when cycle is in progress. In an emergency, first stop cycle by pressing STOP/RESET touch pad and wait for water flow to stop. Wear appropriate Personal Protective Equipment (PPE) whenever reaching into chamber.
- After pressing STOP/RESET touch pad, wait until water flow stops before slowly opening door. Hot water/steam may be sprayed through door opening if door is opened too soon.

1. Press **STOP/RESET** touch pad to halt cycle in progress. Display shows:

**STOP WAS PRESSED
PRESS START TO RESUM**

alternating with:

**LIGHT HOT
RINSE1**

2. Press **STOP/RESET** touch pad a second time to abort cycle. Display shows:

CYCLE ABORTED

and printer records:

CYCLE ABORTED 2:42:P

Control automatically aborts cycle operation and returns screen to selected Cycle menu:

**LIGHT MEDIUM
HEAVY CYCLE 4**

_Indicates flashing position.

4.10 Shutdown

NOTE: Control should be placed in Standby mode after last cycle of the day and when washer is not in use for an extended period of time.

At the end of a work session, the washer should be shut down and cleaned thoroughly. Refer to **SECTION 6, ROUTINE MAINTENANCE**, for complete cleaning instructions and scheduled minor maintenance.

1. Position **POWER-OFF/STANDBY** switch to **OFF/STANDBY**. Display shows:

**STANDBY CYCLE WILL
START IN 01:00**

2. There is a one-minute countdown before STANDBY cycle starts. This delay allows operator to cancel STANDBY cycle and come back to Automatic mode by positioning **POWER-OFF/STANDBY** back to **POWER**.

After a one-minute delay, if **POWER-OFF/STANDBY** is left in **OFF/STANDBY** position, sump and optional pure water tank are drained for two minutes. If option applies, drain discharge cooldown system cools effluents before water is sent to drain. Printer records:

STANDBY CYCLE START

2:51:32P

and display shows:

STANDBY CYCLE TIME	
LEFT=	02:00

3. When SHUTDOWN cycle is completed and control goes into Standby mode, interior chamber light remains **ON**. Printer records:

STANDBY CYCLE END

2:53:32P

and display shows:

00:00:00 P

4. To perform maintenance on washer, position power switch, located behind upper service panel, to **OFF**.
5. Position building electrical disconnect switch (circuit breaker) to **OFF** and close building supply lines.
6. Clean unit as described in *SECTION 6, ROUTINE MAINTENANCE*.
7. Ensure building electrical disconnect switch and power switch are positioned to **ON** after completion of cleaning and minor maintenance procedures.

NOTE: Leaving power switch to OFF position overnight shortens life span of battery backed-up control memory.

4.11 Power Door Operation



WARNING – BURN HAZARD:

- Except for an emergency, do not open door when cycle is in progress. In an emergency, first stop cycle by pressing STOP/RESET touch pad and wait for water flow to stop. Wear appropriate Personal Protective Equipment (PPE) whenever reaching into chamber.
- After pressing STOP/RESET touch pad, wait until water flow stops before slowly opening door. Hot water/steam may be sprayed through door opening if door is opened too soon.

4.11.1 Door Obstruction



WARNING—PERSONAL INJURY AND/OR EQUIPMENT DAMAGE HAZARD:

- If an obstruction is present in wash chamber door, door safety sensor will detect obstruction and door will automatically stop closing. Wait until door is fully open and water flow has stopped before removing obstruction.
- If an obstruction is present in wash chamber door and door is unable to raise, DO NOT attempt to remove obstruction from under door. Door cables may have loosen which could cause door to close at high speed when obstruction is removed. Call a qualified service technician to safely remove an obstruction.

Power door is controlled by touch pads located on the control panel (refer to Figure 3-2).

IMPORTANT: Keep chamber door closed between cycles and when washer is not in use.

Press **DOOR OPEN** touch pad to automatically raise door to open position.

Press **DOOR CLOSE** touch pad to automatically lower door to closed position.

If unit is equipped with power double doors, a door-interlock safety feature allows only one door to be opened at a time to avoid cross-contamination.

Load door can be operated only from load side control panel, and unload door can be operated only from unload side control panel. Unload side door can be opened **ONLY AFTER COMPLETION OF A CYCLE**. Load side door can be opened at any time with operator following appropriate *Safety Precautions*.

If an obstruction is present in wash chamber door, do not attempt to remove object. A door safety sensor detects obstruction. Door automatically stops from closing and opens completely. An alarm sounds and display shows:

**ALARM:
DOOR OBSTRUCTION**

alternating with:

**CYCLE STOPPED
PRESS START TO RESUM**

1. Press **ALARM REPLY** touch pad to silence buzzer.
2. Once door is completely open, carefully remove obstruction from wash chamber door.
3. Press **CYCLE/START** touch pad. Door closes and cycle operation resumes.

4.11.2 Power Door Operation During a Power Failure



WARNING—PERSONAL INJURY HAZARD:

- In case of power loss, power door(s) lowers slowly by gravity. Keep hands and items out of door area to avoid personal injury.
- Chamber door is heavy. Lifting it manually may require two people.



CAUTION – POSSIBLE EQUIPMENT DAMAGE: Once chamber door has been lowered, ensure cable is correctly aligned and routed on all six cable pulleys.

To raise door, proceed as follows:

1. Loosen screws from bottom right and left hand corners (see Figure 4-9) of upper service access panel(s).
2. Pull and lift upper service access panel(s) to remove.
3. Verify door cables are seated in pulley grooves (six pulleys). Secure door in open position:

NOTE: The following steps may require two people.

- a. Remove quick release pin from inside chamber.
- b. Lift door using handle located at top of door (see Figure 4-9).
- c. Insert quick release pin into safety door stop (see Figure 4-10).

NOTE: Flip bottom corner silicone gasket towards front before lowering door on safety door stop.

- d. Slowly lower door on safety door stop.

To close door, proceed as follows:

NOTE: When lowering door, do not pull cable toward front of unit, as this may cause cable to disengage from pulley grooves.

1. Remove quick release pin from safety door stop (see Figure 4-10).
2. Slowly lower door.
3. Ensure cable is properly engaged in pulleys.
4. Store quick release pin into original position (see Figure 4-10).
5. Reinstall upper service access panel and secure with previously removed screws.

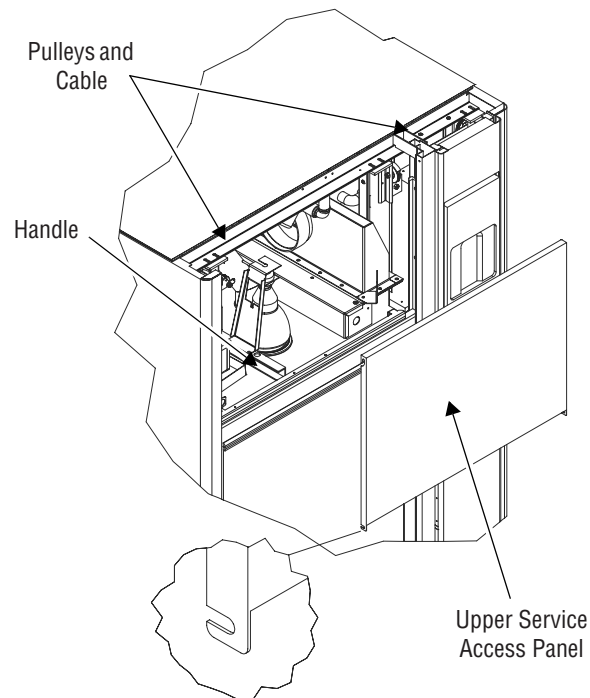

Figure 4-9. Power Door Operation During a Power Failure

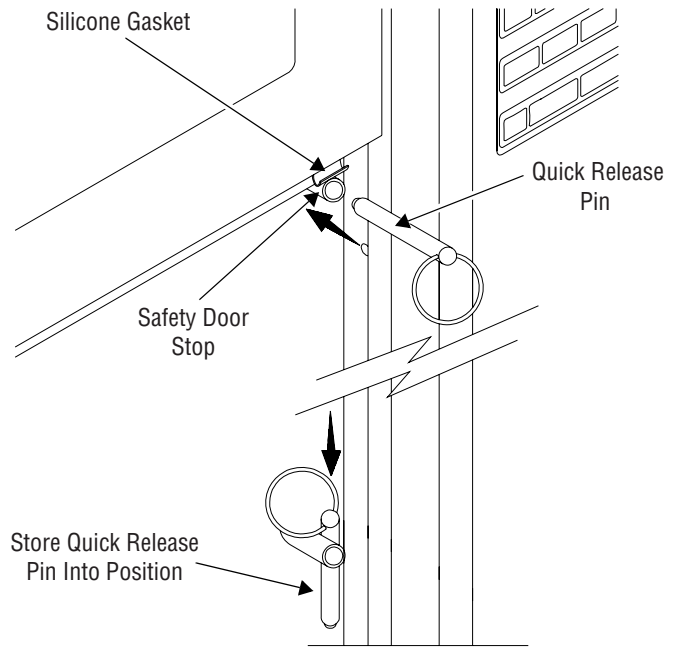

Figure 4-10. Safety Door Stop (Reliance 400 Only)



IMPORTANT: A listing of the Safety Precautions to be observed when operating and servicing this glassware washer can be found in SECTION 1 of this manual. Do not operate the equipment until you have become familiar with this information.

5.1 General



CAUTION – POSSIBLE EQUIPMENT DAMAGE: Always select a cycle appropriate for the items being processed. Failure to do so may result in product damage.

Reliance® 400 Laboratory Glassware Washer and Reliance® 500 Laboratory Glassware Washer are programmed at factory for **three operating cycles:**

- **LIGHT** – For processing lightly soiled or delicate items.
- **MEDIUM** – For processing beakers, bottles and jars.
- **HEAVY** – For processing heavily soiled beakers, bottles and jars.

(In addition, a DESCALER cycle is programmed at factory to help with routine maintenance. Refer to SECTION 6, ROUTINE MAINTENANCE, for more information).

Cycles include various sequences of treatments:

NOTE: See Table 5-1, Cycle Description Chart, for treatment specifications.

- Pre-Wash
- Wash
- Rinse
- Pure Water Rinse
- Drying (option)

Each treatment has time and/or temperature values, some of which can be modified within a range. To help ensure safe and effective operation, some pre-set values cannot be modified.

Table 5-1. Reliance 400 / Reliance 500 Laboratory Glassware Washer – Cycle Description Chart

PHASE:	PRE-WASH (1 TO 4)		WASH (1 TO 5)		RINSE 1		RINSE 2		PURE WATER (1 TO 4) ⁽²⁾		DRYING (OPTION)		COOLING		
	RE-CIRCULATED DEFAULT	SELECT	RE-CIRCULATED DEFAULT	SELECT	RE-CIRCULATED DEFAULT	SELECT	RE-CIRCULATED DEFAULT	SELECT	NON-RE-CIRCULATED DEFAULT	RE-CIRCULATED DEFAULT	NON-RE-CIRCULATED DEFAULT	RE-CIRCULATED DEFAULT	NON-RE-CIRCULATED DEFAULT	RE-CIRCULATED DEFAULT	SELECT
CIRCULATION TIME ⁽¹⁾	01:00	00:15 TO 15:00	SEE CYCLES	00:15 TO 15:00	01:00	00:15 TO 15:00	01:00	00:15 TO 15:00	00:10	01:00	00:15 TO 15:00	15:00	00:15 TO 30:00	1:00	00:00 TO 30:00
INJECTION PUMP SELECTION:			PUMP 1												
WATER TYPE OR AIR TEMP	HTW ⁽⁵⁾	CTW ⁽⁵⁾ HTW	HEATED 65.0°C (150.0°F)	HEATED 60°C (140.0°F) TO 88.0°C (190.0°F)	HTW	HTW	HTW	HEATED 43.0°C (100.0°F) TO 88.0°C (190.0°F)	PURE WATER FROM TANK (OPTION)	PURE WATER FROM TANK OR HEATED IN SUMP 82°C (180°F)	PURE W. FROM TANK HEATED IN SUMP 15.0°C (60.0°F) TO 88.0°C (190.0°F)	AIR HEATED AT 115.0°C (240.0°F) SET POINT, NOT MAINTAINED	65.0°C (150°F) TO 115.0°C (240.0°F)		

	MOTOR SPEED	IF SELECTED	IF SELECTED	IF SELECTED	IF SELECTED	IF SELECTED	IF SELECTED	IF SELECTED	IF SELECTED	IF SELECTED	IF SELECTED	IF SELECTED	IF SELECTED	IF SELECTED	IF SELECTED
C	LIGHT	X	X	X	X	X	X	X	X	X	X	X	X	X	X
Y	MEDIUM	X	X	X	X	X	X	X	X	X	X	X	X	X	X
C	HEAVY	X	X	X	X	X	X	X	X	X	X	X	X	X	X
L	4 to 10	IF SELECTED	IF SELECTED	IF SELECTED	IF SELECTED	IF SELECTED	IF SELECTED	IF SELECTED	IF SELECTED	IF SELECTED	IF SELECTED	IF SELECTED	IF SELECTED	IF SELECTED	IF SELECTED
E	DESCALER														
S															

ADJUSTABLE IN SERVICE MODE

SUMP FILL ALARM TIME: 04:00 [01:00-15:00]

SUMP GRAVITY DRAIN ALARM TIME: 07:15 [01:00-15:00]

SUMP HEATING ALARM: 10:00 [01:00-15:00]

*STEAM HEATED UNIT: 30:00-59:00 [30:00-59:00]

*ELECTRIC HEATED UNIT: 00:45 [01:00-15:00]

PURE WATER TANK FILL ALARM TIME: 10:00 [01:00-15:00]

PURE WATER HEATING ALARM TIME (OPTION): 10:00 [01:00-15:00]

*STEAM HEATED UNIT: 45:00 [01:00-15:00]

*ELECTRIC HEATED UNIT: 45:00 [01:00-15:00]

PURE WATER TANK TEMPERATURE (OPTION): 82.0°C (180.0°F) [15.0°C (60.0°F) - 88.0°C (190.0°F)]

VAPOR REMOVAL TIME: 02:00 [02:00-15:00]

*STEAM HEATED UNIT: 02:45 [01:00-15:00]

*ELECTRIC HEATED UNIT: 02:45 [01:00-15:00]

ADJUSTABLE IN AUTOMATIC MODE

PUMP 1 NAME: PUMP 1 [9 CHARACTERS]

PUMP 2 NAME: PUMP 2 [9 CHARACTERS]

PUMP 3 NAME: PUMP 3 [9 CHARACTERS]

PUMP 4 NAME: PUMP 4 [9 CHARACTERS]

POWDER NAME: POWDER [9 CHARACTERS]

INJECTION TIME (7): 00:45 [00:20-03:00]

INJECTION UNIT CONVERSION: MIN.:SEC. 00:11 1/8 M/L 1.0

00:22 1/4 M/L 2.0

00:44 1/2 M/L 3.9

01:06 3/4 M/L 7.8

01:28 1-1/4 M/L 11.7

02:12 1-1/2 M/L 13.7

02:34 1-3/4 M/L 15.6

02:56 2 M/L 15.6

GENERAL NOTES:

- TREATMENT TIME DOES NOT INCLUDE FILLING, HEATING, AND DRAINING TIMES.
- PURE WATER TREATMENT ALWAYS PERFORMED AT LOW SPEED.
- DEFAULT SETTING IS COLD WATER IF OPTION APPLIES.
- IF COLD WATER IS AVAILABLE.
- ONE LEVEL - LOW SPEED ONLY (WITHOUT UNIVERSAL SHELVING SYSTEM)
- TWO LEVELS - HIGH SPEED ONLY (WITH UNIVERSAL SHELVING SYSTEM)
- MANUALLY ADD 25 OZ (740 mL) OF DESCALER - RATE OF 2 OZ/GAL (16 mL/L)
- 45 SECONDS EQUAL 1/2 OZ/GAL US (4 mL/L) APPROXIMATELY (SEE INJECTION UNIT CONVERSION).

5.2 Change Values Mode

Three paths are available to customize cycles to suit specific needs. It is possible to modify factory pre-set cycles, add or remove cycle treatments or create a personalized cycle configuration (see Figure 5-1).

Change Values mode allows authorized operators to modify or add treatment values in, or remove from, existing cycles, create new cycles or modify miscellaneous operating values. Change Values mode consists of four functions: MODIFY, ADD/CREATE, REMOVE and EXIT (see Figure 5-2).

NOTE: If access code feature is enabled, operator must enter access code before entering Change Values mode (see Figure 5-10).

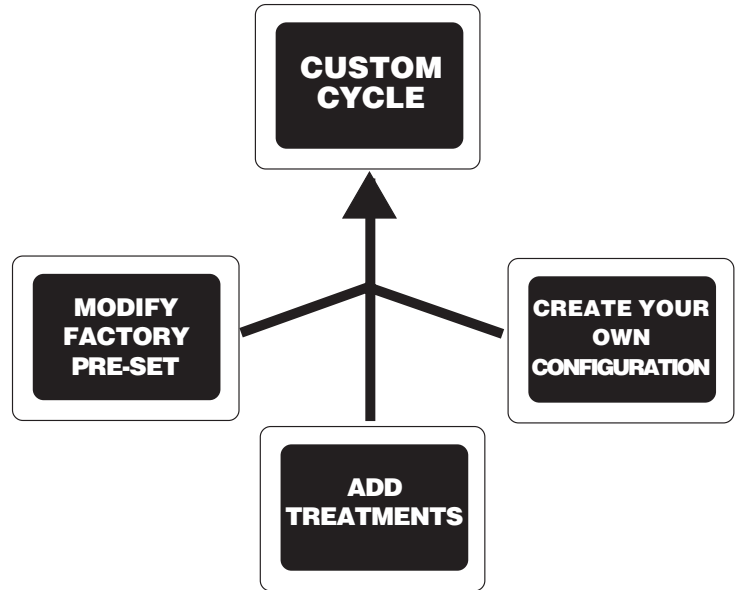

Figure 5-1. Change Values Mode Functions

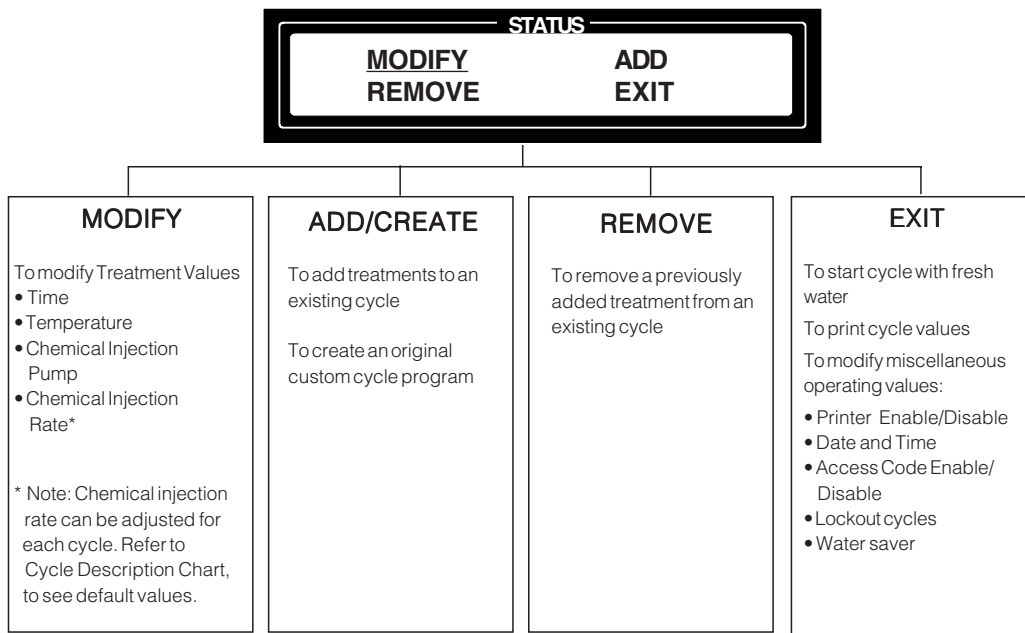

Figure 5-2. Change Values Mode – Program Tree

5.3 Treatment Sequence and Display Screens

In Change Values mode, cycles are modified or created by selecting a treatment, then modifying values on a series of display screens. Process is repeated for each selected treatment until a customized cycle is complete.

The six cycle treatment types available occur in a sequential order which may not be changed. Treatments may be added or removed entirely from the operating sequence; however, control only allows placement of treatments that follow normal sequence. For example, a Pre-Wash treatment added to the cycle always occurs after an existing Pre-Wash treatment, never after a Wash treatment.

Treatments and corresponding treatment value screens occur in the following order:

- **Pre-Wash** (one to four Pre-Wash treatments available):

SELECT WATER TEMP.	
<u>COLD</u>	HOT

__ indicates flashing position

followed by:

PRE-WASH1
<u>XX:XX</u>

__ indicates flashing position

- **Wash** (one to five Wash treatments available):

SELECT WATER TEMP.	
<u>HOT</u>	HEATED

__ indicates flashing position

followed by:

PUMP1	WASH1
<u>XX:XX</u>	TMP=XXX.XF

__ indicates flashing position

followed by:

DETERGENT TO INJECT?
<u>PUMP1</u>

__ indicates flashing position

- **Rinse** (one to four Rinse treatments available):

Rinse 1:

SELECT WATER TEMP.		
<u>COLD</u>	HOT	HEATED

__ indicates flashing position

followed by:

RINSE1 <u>XX:XX</u>

___ indicates flashing position

Rinse 2:

SELECT WATER TEMP. <u>COLD</u> HOT HEATED
--

___ indicates flashing position

followed by:

RINSE2 <u>XX:XX</u>

___ indicates flashing position

- **Pure Water Rinse** (one to four Pure Water Rinse treatments available):

RECIRCULATION TYPE <u>RECIRC.</u> NON-RECIRC.

___ indicates flashing position

- **Drying (option):**

DRYING TP = XXX.XF <u>TIME= XX:XX</u>

___ indicates flashing position

5.4 Modifying Factory-Set Cycles

MODIFY function of Change Values mode is used to alter the values of specific treatments in existing programmed cycles.

The following procedure and flowchart (see Figure 5-3) show, as an example, the procedure for modifying the Pre-Wash treatment of a cycle.

1. Set the **POWER-OFF/STANDBY** switch, located behind printer door, to **POWER**. Unit name temporarily appears on screen, then display shows first Cycle menu:

<u>LIGHT</u> MEDIUM
HEAVY CYCLE 4

___ indicates flashing position

NOTE: To scroll through available Cycle menus, press **CYCLE MENU** touch pad.

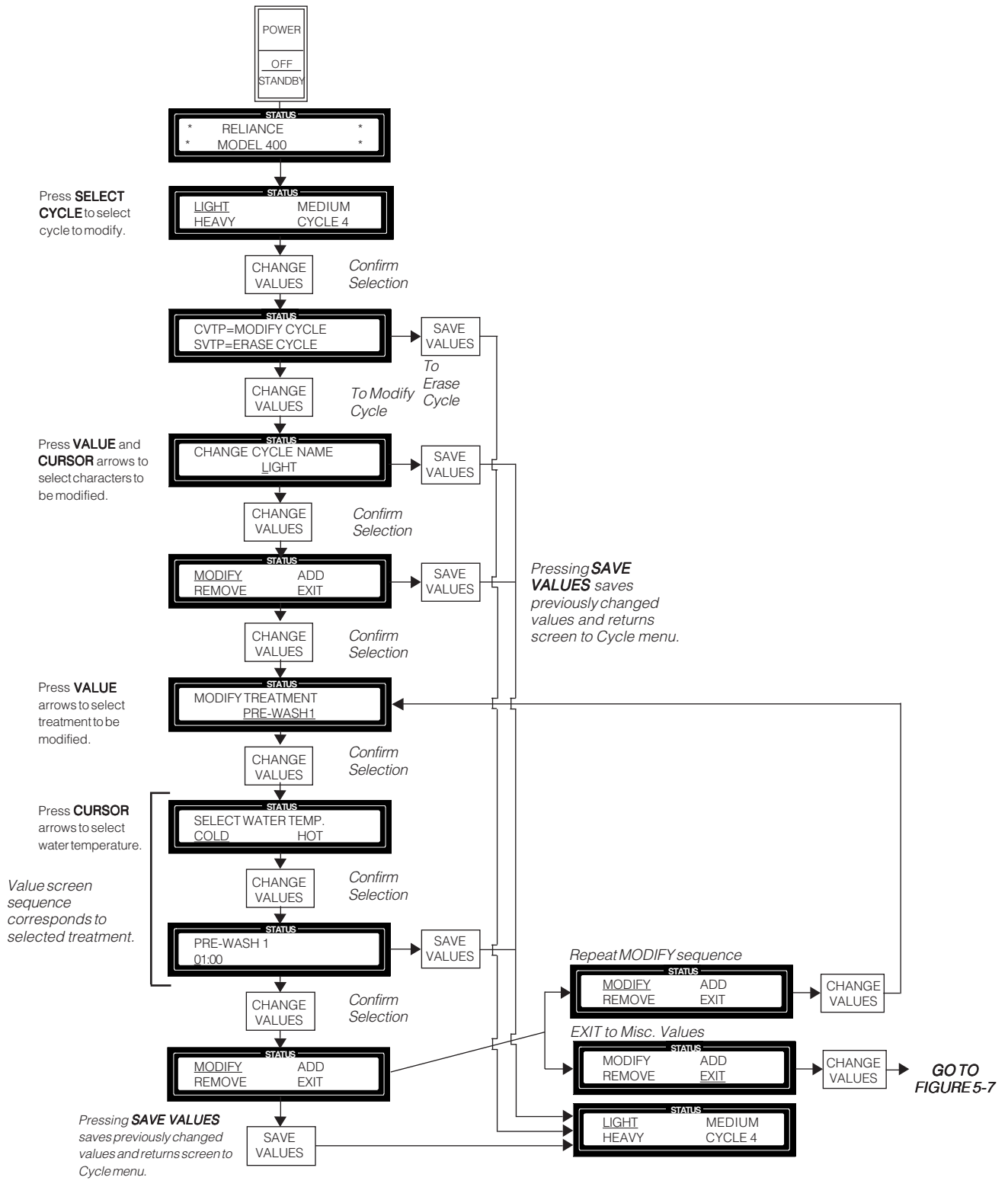
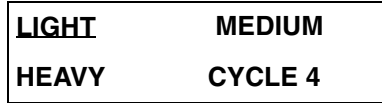

Figure 5-3. Change Values Mode – Modifying Cycle Treatments



2. Press **SELECT CYCLE** touch pad until desired cycle name flashes:



__ indicates flashing position



3. When desired cycle name is flashing, press **CHANGE VALUES** touch pad to access Change Values mode. Printer records:

*CHANGE VALUE 8:44:51A

and display shows:

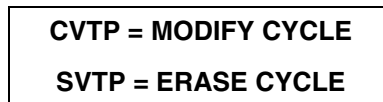

NOTE: When modifying a cycle, note the following:

- 1) Pressing **SAVE VALUES** touch pad erases the selected cycle from control memory. Cycle reverts to a numbered unprogrammed listing on the Cycle menu.
- 2) If access code feature is enabled and the selected cycle is locked out, the access code sequence (see Figure 5-10) appears after **CHANGE VALUES** touch pad is pressed.
- 3) New value entries must be confirmed by pressing **CHANGE VALUES** touch pad. Change Values mode may be exited at any time by pressing **SAVE VALUES** touch pad. Control saves confirmed values and returns screen to selected Cycle menu.



4. Press **CHANGE VALUES** touch pad. Change Cycle Name screen appears:



__ indicates flashing position



5. Press **CHANGE VALUES** touch pad. Change Values menu screen appears:

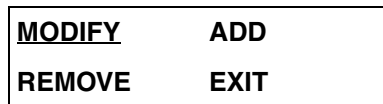

__ indicates flashing position



6. Press **CHANGE VALUES** touch pad to confirm MODIFY function selection. Modify Treatment screen appears:

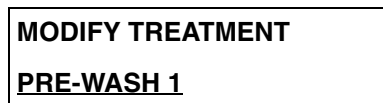

__ indicates flashing position



Press **VALUE arrows** (up or down) to scroll through treatments until desired treatment name is flashing.



- Press **CHANGE VALUES** touch pad to confirm treatment selection. Pre-Wash Water Temperature Selection screen appears:

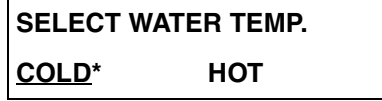

__ indicates flashing position

* If option applies.

Press **CURSOR arrows** (left or right) to toggle between COLD and HOT.



- Press **CHANGE VALUES** touch pad to confirm temperature selection. Pre-Wash Time Value screen appears:

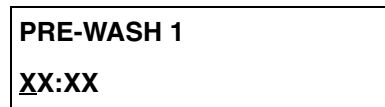

__ indicates flashing position

To enter Pre-Wash treatment time, press **CURSOR arrows** (left or right) to select position and **VALUE arrows** (up or down) to select desired number (0-9). Treatment time is input as minutes and seconds within a range of 0-15 minutes and 0-99 seconds.

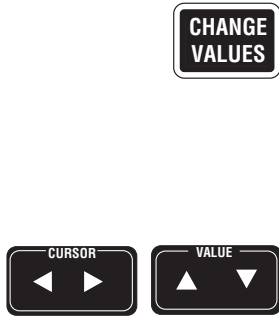

- Press **CHANGE VALUES** touch pad to confirm time entry. Change Values menu screen appears:

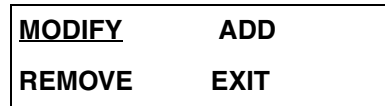

__ indicates flashing position

- At this point, operator has option to either continue in Change Values mode, or to save values and exit Change Values mode.

- To exit Change Values mode, press **SAVE VALUES** touch pad. Control saves changed values and returns screen to selected Cycle menu.
- To continue in Change Values mode, press **CURSOR arrows** (left or right) or **VALUE arrows** (up or down) to select function. Press **CHANGE VALUES** touch pad to confirm selection and initiate function program.



5.5 Adding Cycle Treatments

ADD function of Change Values mode is used to insert treatments in the operating sequence of a programmed cycle.

NOTE: A total of 15 programmed treatments are allowed in a cycle. Total allowed number of each treatment type varies. See **Table 5-1, Cycle Description Chart**, for specific treatment parameters.

The following procedure and flowchart (see Figure 5-4) show, as an example, procedure for adding a new Pre-Wash treatment to a cycle.

1. Set **POWER-OFF/STANDBY** switch, located behind printer door, to **POWER**. Unit name temporarily appears on screen, then screen displays first Cycle menu:

<u>LIGHT</u>	MEDIUM
HEAVY	CYCLE 4

___ indicates flashing position

NOTE: To scroll through available Cycle menus, press **CYCLE MENU** touch pad.



2. Press **SELECT CYCLE** touch pad until desired cycle name flashes:

LIGHT	<u>MEDIUM</u>
HEAVY	CYCLE 4

___ indicates flashing position



3. When desired cycle name is flashing, press **CHANGE VALUES** touch pad to access the Change Values mode. Printer records:

*CHANGE VALUE 8:44:51A

and following screen appears:

CVTP = MODIFY CYCLE
SVTP = ERASE CYCLE

NOTE: When changing a cycle, note the following:

- 1) Pressing **SAVE VALUES** touch pad erases selected cycle from control memory. Cycle reverts to a numbered unprogrammed listing on Cycle menu.
- 2) If access code feature is enabled and selected cycle is locked out, access code sequence (see Figure 5-10) appears after **CHANGE VALUES** touch pad is pressed.
- 3) Change Values mode may be exited at any time by pressing **SAVE VALUES** touch pad. New value entries must be confirmed by pressing **CHANGE VALUES** touch pad. Control saves confirmed values and returns screen to selected Cycle menu.

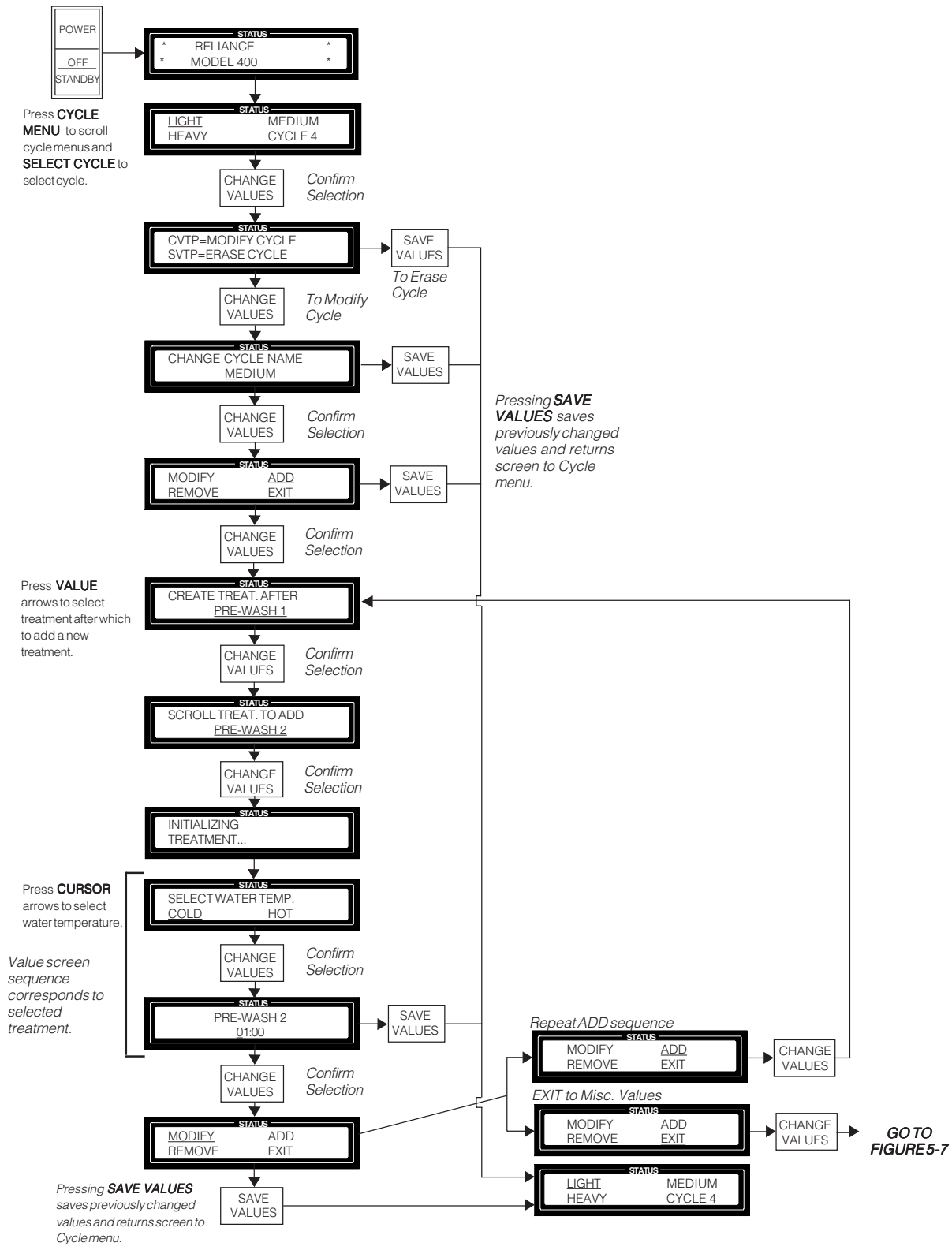

Figure 5-4. Change Values Mode – Adding Cycle Treatments



- When desired cycle name is flashing, press **CHANGE VALUES** touch pad to access Change Values mode. Display shows:



__ indicates flashing position



To change cycle name, press **CURSOR arrows** (left or right) to select position and **VALUE arrows** (up or down) to select desired letter, number, punctuation or space. Cycle name can be a maximum of nine characters, including spaces.



- Press **CHANGE VALUES** touch pad. Change Values menu screen appears:

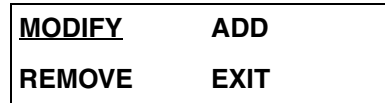

__ indicates flashing position



- Press **CURSOR arrows** (left or right) or **VALUE arrows** (up or down) to select ADD function:

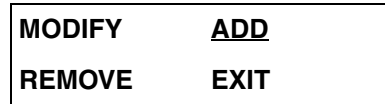

__ indicates flashing position



- Press **CHANGE VALUES** touch pad to confirm ADD function selection. Create Treatment screen appears:

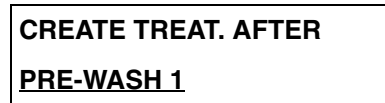

__ indicates flashing position

NOTE: If only one treatment is programmed in the cycle, or if it is possible to add only one treatment type, display goes directly to Scroll Treatment to Add screen:



To select position in cycle where treatment is added, press **VALUE arrows** (up or down) to scroll through treatments until treatment name is flashing.

IMPORTANT: If Pre-Wash treatment has been deleted, it is not possible to add a treatment before Wash treatment. Control does not allow restoring Pre-Wash treatment into cycle. In this case, erase whole cycle and create a new one starting with a Pre-Wash treatment so you can add desired treatments after Pre-Wash treatment.



- Press **CHANGE VALUES** touch pad to confirm additional treatment is added **after** selected treatment. Add Treatment screen appears:

SCROLL TREAT. TO ADD
PRE-WASH

 indicates flashing position

Press **VALUE arrows** (up or down) to scroll through treatments until desired treatment name is flashing.



- Press **CHANGE VALUES** touch pad to confirm and add selected treatment to programmed cycle. The Treatment Initialization screen appears:

INITIALIZING
TREATMENT...

then Pre-Wash Water Temperature Selection screen appears:

SELECT WATER TEMP.
COLD* HOT

 indicates flashing position

*** If option applies.**

Press **CURSOR arrows** (left or right) to toggle between COLD and HOT.



- Press **CHANGE VALUES** touch pad to confirm temperature selection. Pre-Wash Time Value screen appears:

PRE-WASH 2
XX:XX

 indicates flashing position

To enter Pre-Wash treatment time, press **CURSOR arrows** (left or right) to select position and **VALUE arrows** (up or down) to select desired number (0-9). Treatment time is input as minutes and seconds within a range of 0-15 minutes and 0-99 seconds.



- Press **CHANGE VALUES** touch pad to confirm time entry. Change Values menu screen appears:

MODIFY ADD
REMOVE EXIT

 indicates flashing position

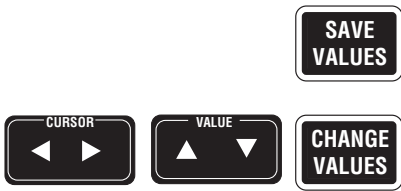

12. At this point operator has option to either continue in Change Values mode, or to save values and exit Change Values mode.

- To exit Change Values mode, press **SAVE VALUES** touch pad. Control saves changed values and returns screen to selected Cycle menu.
- To continue in Change Values mode, press **CURSOR arrows** (left or right) or **VALUE arrows** (up or down) to select function. Press **CHANGE VALUES** touch pad to confirm selection and initiate function program.

5.6 Creating Custom Cycles

CREATE function of Change Values mode is used to initiate programming of custom cycles. This function is only available for a selected cycle with no programmed treatments. Numbered cycles (4-10) on the Cycle menu are available for custom programming.

The following procedure and flowchart (see Figure 5-5) show, as an example, the procedure for creating a new cycle with a Pre-Wash as the first treatment.

1. Set **POWER-OFF/STANDBY** switch, located behind printer door, to **POWER**. Unit name temporarily appears on screen, then screen displays first Cycle menu:

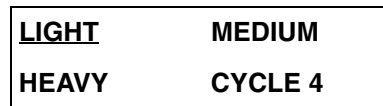

___ indicates flashing position

NOTE: To scroll through available Cycle menus, press **CYCLE MENU** touch pad.

2. Press **SELECT CYCLE** touch pad until desired empty cycle name flashes.

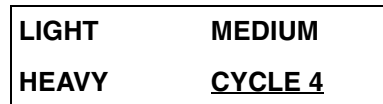

___ indicates flashing position

3. Press **CHANGE VALUES** touch pad to access Change Values mode. Printer records:



*CHANGE VALUE 8:44:51A

and display shows:



___ indicates flashing position

To change cycle name, press **CURSOR arrows** (left or right) to select position and **VALUE arrows** (up or down) to select desired letter, number, punctuation or space. Cycle name can be a maximum of nine characters, including spaces.



*NOTE: Change Values mode may be exited at any time by pressing **SAVE VALUES** touch pad. New value entries must be confirmed by pressing **CHANGE VALUES** touch pad. Control saves confirmed values and return screen to selected Cycle menu.*



4. Press **CHANGE VALUES** touch pad. Change Values menu screen appears:

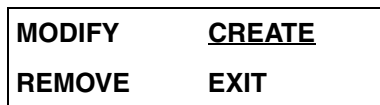

__ indicates flashing position

*NOTE: CREATE function is displayed only when creating **first** treatment of a custom cycle. To continue programming custom cycle, use ADD function.*



5. Press **CHANGE VALUES** touch pad to confirm CREATE function selection. Add Treatment screen appears:

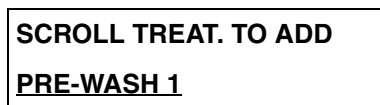

__ indicates flashing position

Press **VALUE** arrows (up or down) to scroll through treatments until desired treatment name is flashing.



IMPORTANT: *When developing a custom cycle, operator must be accurate in selecting first treatment of cycle. Control only allows placement of treatments that follow normal sequence. For example, if first treatment selected was a Wash treatment, it is not possible to add a Pre-Wash treatment to the cycle.*

*NOTE: If maximum number of treatment type selected allowed in cycle is reached (see **Table 5-1, Cycle Description Chart**), display shows: **NO ROOM IN THIS TREATMENT TYPE.***



6. Press **CHANGE VALUES** touch pad to confirm and add selected treatment to custom cycle. Treatment Initialization screen appears:

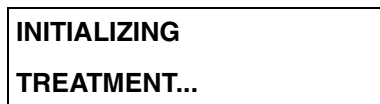

...then Pre-Wash Water Temperature Selection screen appears:

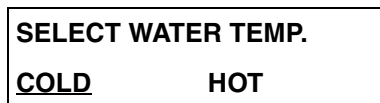

__ indicates flashing position

*** If option applies.**

Press **CURSOR** arrows (left or right) to toggle between COLD and HOT.





- Press **CHANGE VALUES** touch pad to confirm temperature selection. Pre-Wash Time Value screen appears:



— indicates flashing position



To enter Pre-Wash treatment time, press **CURSOR arrows** (left or right) to select position and **VALUE arrows** (up or down) to select desired number (0-9). Treatment time is input as minutes and seconds within a range of 0-15 minutes and 0-99 seconds.



- Press **CHANGE VALUES** touch pad to confirm time entry. Change Values menu screen appears:

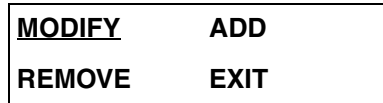

— indicates flashing position

- At this point, operator has the option to either continue in Change Values Mode, or to save values and exit Change Values mode.

- To exit Change Values mode, press **SAVE VALUES**. Control saves changed values and returns screen to selected Cycle menu.
- To continue in Change Values mode, press **CURSOR arrows** (left or right) or **VALUE arrows** (up or down) to select function. Press **CHANGE VALUES** touch pad to confirm selection and initiate function program.



5.7 Removing Treatments From Cycles

REMOVE function of the Change Values mode is used to delete treatments from a programmed cycle.

The following procedure and flowchart (see Figure 5-6) show, as an example, the procedure for deleting Pre-Wash treatment from a cycle.

- Set **POWER-OFF/STANDBY** switch, located behind printer door, to **POWER**. Unit name temporarily appears on screen, then screen displays first Cycle menu:

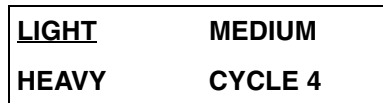

— indicates flashing position

NOTE: To scroll through available Cycle menus, press **CYCLE MENU** touch pad.

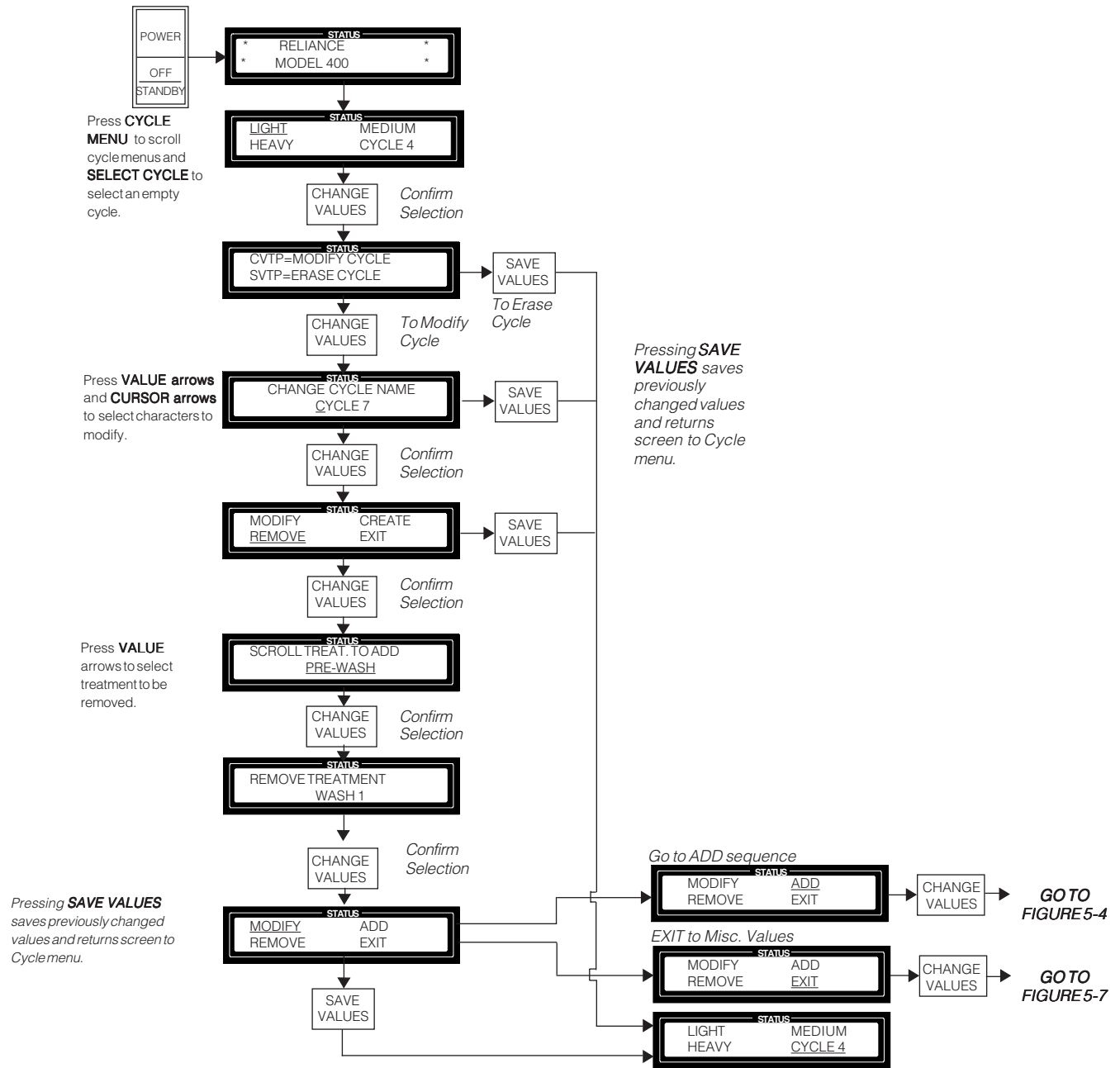
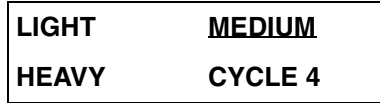

Figure 5-6. Change Values Mode – Removing Treatments From Cycles



2. Press **SELECT CYCLE** touch pad until desired cycle name flashes.



__ indicates flashing position

NOTE: To scroll through available Cycle menus, press **CYCLE MENU** touch pad.



3. When desired cycle name is flashing, press **CHANGE VALUES** touch pad to access Change Values mode. Printer records:

*CHANGE VALUE 8:44:51A

and following screen appears:

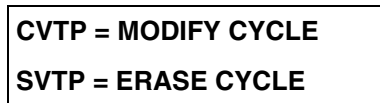

NOTE: when changing a cycle, note the following:

- 1) Pressing **SAVE VALUES** touch pad erases selected cycle from control memory. Cycle reverts to a numbered unprogrammed listing on Cycle menu.
- 2) If access code feature is enabled and selected cycle is locked out, access code sequence (see Figure 5-10) appears after **CHANGE VALUES** touch pad is pressed.
- 3) Change Values mode may be exited at any time by pressing **SAVE VALUES** touch pad. New value entries must be confirmed by pressing **CHANGE VALUES** touch pad. Control saves confirmed values and returns screen to selected Cycle menu.



4. Press **CHANGE VALUES** touch pad. Change Cycle Name screen appears:



__ indicates flashing position

IMPORTANT: If Pre-Wash treatment has been deleted, it is not possible to add a treatment before Wash treatment. Control does not allow restoring Pre-Wash treatment into cycle. In this case, erase whole cycle and create a new one starting with a Pre-Wash treatment so you can add desired treatments after Pre-Wash treatment.



5. Press **CHANGE VALUES** touch pad. Change Treatment menu screen appears:

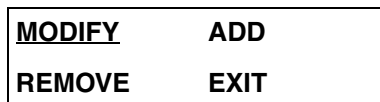

__ indicates flashing position



6. Press **CURSOR arrows** (left or right) or **VALUE arrows** (up or down) to select REMOVE function.

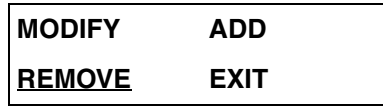

— indicates flashing position



7. Press **CHANGE VALUES** touch pad to confirm REMOVE function selection. Remove Treatment screen appears:

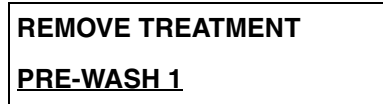

— indicates flashing position

To select treatment to be removed, press **VALUE arrows** (up or down) to scroll through treatments until desired treatment name is flashing.



8. Press **CHANGE VALUES** touch pad to confirm and remove selected treatment from programmed cycle. Change Values menu screen appears:

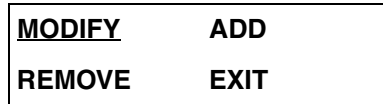

— indicates flashing position

9. At this point, operator has option to either continue in Change Values mode, or to save values and exit Change Values mode.

- To exit Change Values mode, press **SAVE VALUES** touch pad. Control saves changed values and returns screen to selected Cycle menu.
- To continue in Change Values mode, press **CURSOR arrows** (left or right) or **VALUE arrows** (up or down) to select function. Press **CHANGE VALUES** to confirm selection and initiate the function program.



5.8 Changing Miscellaneous Values

EXIT function of Change Values mode is used to program various operating values and enable/disable optional features and access code.

Following procedure and flowchart (see Figure 5-7) show the complete sequence of miscellaneous values display screens.

1. Set **POWER-OFF/STANDBY** switch, located behind printer door, to **POWER**. Unit name temporarily appears on screen, then screen displays first Cycle menu:

<u>L</u> IGHT	MEDIUM
HEAVY	CYCLE 4

__ indicates flashing position

NOTE: When changing a cycle, note the following:

- 1) *Change Values mode may be exited at any time by pressing **SAVE VALUES** touch pad. New value entries must be confirmed by pressing **CHANGE VALUES** touch pad. Control saves confirmed values and returns screen to selected Cycle menu.*
- 2) *If access code feature is enabled and selected cycle is locked out, access code sequence (see Figure 5-10) appears after **CHANGE VALUES** is pressed.*



2. Press **CHANGE VALUES** touch pad to access Change Values mode. printer records:

*CHANGE VALUE 8:44:51A

...and display shows:

CVTP=MODIFY CYCLE
SVTP=ERASE CYC

*NOTE: Pressing **SAVE VALUES** touch pad erases the selected cycle from control memory. Cycle reverts to a numbered unprogrammed listing on Cycle menu.*



3. Press **CHANGE VALUES** touch pad. Change Cycle Name screen appears:

CHANGE CYCLE NAME
<u>L</u> IGHT

__ indicates flashing position



4. Press **CHANGE VALUES** touch pad. Change Values screen appears:

<u>M</u> ODIFY	ADD
REMOVE	EXIT

__ indicates flashing position



5. Press **CURSOR arrows** (left or right) or **VALUE arrows** (up or down) to select EXIT function:

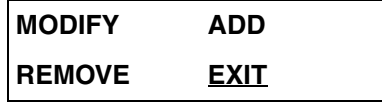

___ indicates flashing position



6. Press **CHANGE VALUES** touch pad to confirm selection. Modify Treatment screen appears:



___ indicates flashing position



7. Press **VALUE arrows** (up or down) to toggle between YES and NO. Display shows:

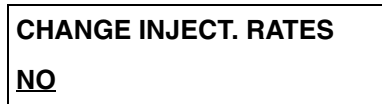

___ indicates flashing position



8. Press **VALUE arrows** (up or down) to toggle between YES and NO.



9. Press **CHANGE VALUES** touch pad to confirm rate entry. Print Cycle Values screen appears:



___ indicates flashing position

NOTE: If printer is disabled, display goes directly to Change Miscellaneous Values screen.



Press **VALUE arrows** (up or down) to toggle between YES and NO. Selecting YES generates a printout of cycle values for the selected cycle. Selecting NO bypasses printing.

*NOTE: Pressing **SAVE VALUES** and then **CHANGE VALUES** touch pads exit Change Values mode and display returns to first Cycle menu.*



10. Press **CHANGE VALUES** touch pad to confirm answer selection. Display shows:

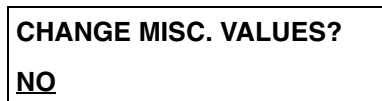

___ indicates flashing position

Press **VALUE arrows** (up or down) to toggle between YES and NO. Selecting NO exits Change Values mode. Selecting YES allows operator to change miscellaneous operating values.

NOTE: If **NO** is selected, pressing **SAVE VALUES** or **CHANGE VALUES** touch pad exits Change Values mode and display returns to first Cycle menu.



- Press **CHANGE VALUES** touch pad to confirm answer selection. Printer Enable/Disable screen appears:

PRINTER ENABLED?	
<u>YES</u>	

 indicates flashing position

Press **VALUE** arrows (up or down) to toggle between YES and NO. Selecting YES automatically generates a printout during cycle operation. Selecting NO disables printer.



NOTE: If **NO** is selected, pressing **SAVE VALUES** or **CHANGE VALUES** touch pad exits Change Values mode and display returns to first Cycle menu.



- Press **CHANGE VALUES** touch pad to confirm answer selection. Date and Time value screen appears:

DATE	<u>00/00/00</u>
TIME	<u>00:00:00</u> AM

 indicates flashing position

To enter correct date and time, press **CURSOR** arrows (left or right) to select position and **VALUE** arrows (up or down) to select desired number (0-9). Date is input as two-digit numerical values for Year/Month/Day. Time is input as Hours/Minutes/Seconds and AM/PM.



- Press **CHANGE VALUES** touch pad to confirm date and time entry. Access code screen appears:

ACCESS CODE	
<u>YES</u>	

 indicates flashing position

NOTE: If access code is already enabled, access code sequence is displayed (see Figure 5-10).

Press **VALUE** arrows (up or down) to toggle between YES and NO. Selecting YES enables access code and cycle lockout features. Selecting NO disables access code feature.



- Press **CHANGE VALUES** touch pad to confirm answer selection. If **NO** is selected, display exits to Change Value mode. If **YES** is selected, new Access Code screen appears:

CHANGE ACCESS CODE?	
NEW CODE =	<u>0000</u>

 indicates flashing position



To enter desired access code, press **CURSOR arrows** (left or right) to select position and **VALUE arrows** (up or down) to select desired number (0-9). Access code is input as a four-digit number from 0000 to 9999.

NOTE: If no access code is entered, 0000 is automatically programmed as access code.



15. Press **CHANGE VALUES** touch pad to confirm value entry. Cycle Lockout screen appears:

CYCLES TO LOCKOUT = 00

__ indicates flashing position



To enter locked-out cycles, press **CURSOR arrows** (left or right) to select position and **VALUE arrows** (up or down) to select desired number (0-9). Cycles to lockout is input as a two-character number within range of 00-11.

NOTE: Cycles are locked out in sequential order. If one cycle is locked out (01), only Cycle 1 requires an operator to enter access code prior to making cycle changes. If four cycles are locked out (04), Cycles 1 through 4 require an access code and Cycles 5 through 10 remain accessible for change by any operator (no access code required).



16. Press **CHANGE VALUES** touch pad to confirm value entry. Display shows:

WATER SAVER ENABLED

YES

__ indicates flashing position



17. Press **VALUE arrows** (up or down) to toggle between YES and NO. If YES is selected, water is saved for **all** cycles processed.
18. Press **CHANGE VALUES** touch pad to return to main Cycle menu.

5.9 Select Injection Time Rate

5.9.1 General

See Figure 5-8.

1. Set **POWER-OFF/STANDBY** switch, located behind printer door, to **POWER**. Unit name temporarily appears on screen, then screen displays first Cycle menu:

<u>LIGHT</u>	MEDIUM
HEAVY	CYCLE 4

__ indicates flashing position

NOTE: When changing a cycle, note the following:

- 1) *Change Values mode may be exited at any time by pressing **SAVE VALUES** touch pad. New value entries must be confirmed by pressing **CHANGE VALUES** touch pad. Control saves confirmed values and returns screen to selected Cycle menu.*
- 2) *If access code feature is enabled and selected cycle is locked out, access code sequence (see Figure 5-10) appears after **CHANGE VALUES** touch pad is pressed.*



2. Press **CHANGE VALUES** touch pad to access Change Values mode. Printer records:

*CHANGE VALUE 8:44:51A

and display shows:

CVTP=MODIFY CYCLE
SVTP=ERASE CYCLE

*NOTE: Pressing **SAVE VALUES** touch pad erases selected cycle from control memory. Cycle reverts to a numbered unprogrammed listing on Cycle menu.*



3. Press **CHANGE VALUES** touch pad. Change Values screen appears:

<u>MODIFY</u>	ADD
REMOVE	EXIT

__ indicates flashing position



4. Press **CHANGE VALUES** touch pad. Change Cycle Name screen appears:

CHANGE CYCLE NAME
<u>LIGHT</u>

__ indicates flashing position

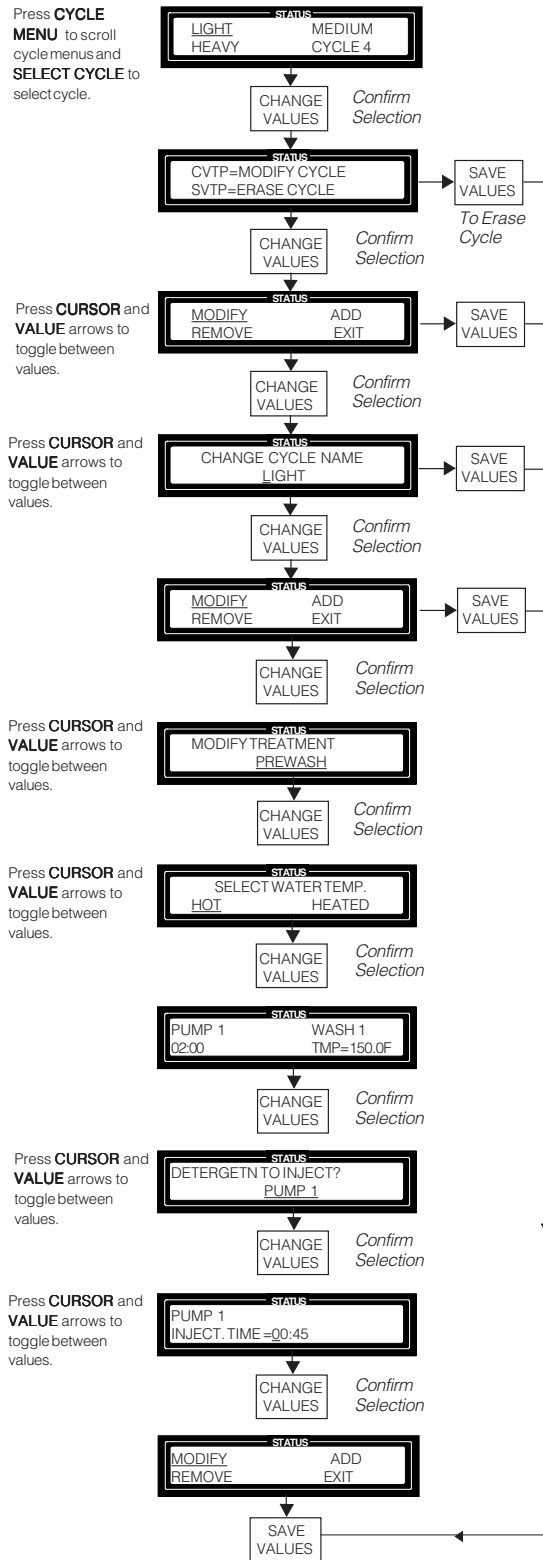
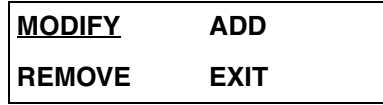

Figure 5-8. Change Values Mode – Select Injection Time Rate



5. Press **CHANGE VALUES** touch pad. Change Values screen appears:



___ indicates flashing position



6. Press **CHANGE VALUES** touch pad. Modify Treatment screen appears:

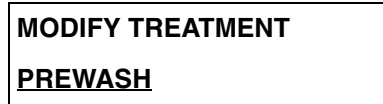

___ indicates flashing position

Press **VALUE arrows** (up or down) to select WASH 1.



7. Press **CHANGE VALUES** touch pad. Select Water Temperature screen appears:

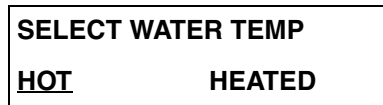

___ indicates flashing position



8. Press **CHANGE VALUES** touch pad. Pump Selection screen appears:

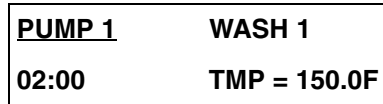

___ indicates flashing position



9. Press **CHANGE VALUES** touch pad. Detergent to Inject screen appears:



10. Press **CHANGE VALUES** touch pad. Select Injection Time screen appears:

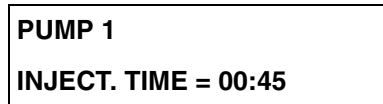

To enter pump injection time, press **VALUE arrows** (up or down) to select desired time. Injection time is input in seconds with a range of 00:20 to 03:00 minutes (see **Table 5-1**, *Cycle Description Chart*; contact STERIS or have a qualified service technician refer to **SECTION 4** in *Maintenance Manual* [P764330-580]).

NOTE: When changing a cycle, note the following:

- 1) *Injection rate is displayed in mL/L.*
- 2) *At low speed, the sump capacity is: 12.6 gal. (47.7 L). At high speed, the sump capacity is increased by 1.5 gal. (5.7 L).*
- 3) *Factory setting for chemical injection is 45 seconds at low speed. Control automatically adjusts chemical injection time at high speed.*
- 4) *Injection time of 45 seconds equals approximately to 1/2 oz/gal (4.0 mL/L).*



11. Press **CHANGE VALUES** to return to confirm.

12. Press **SAVE VALUES** touch pad to return to main Cycle menu.

5.9.2 Verifying Chemical Concentration



See Figure 5-9.

To verify or establish chemical rate, operator may collect water from sample port located behind lower service panel under sump.

1. On Cycle menu, press **SELECT CYCLE** touch pad until desired cycle where injection time was modified appears:

LIGHT	MEDIUM
HEAVY	CYCLE 4

___ indicates flashing position

2. Press **CYCLE/START** touch pad to run cycle.
3. While cycle is running, let water recirculate and when Wash treatment starts, press **STOP/RESET** touch pad.
4. To collect a sample, place a small container under sample port and turn knob counterclockwise. To close sample port, turn knob clockwise.
5. Analyze chemical concentration from sample. Adjust concentration if needed, following procedure described in **SECTION 5.9.1, GENERAL**.

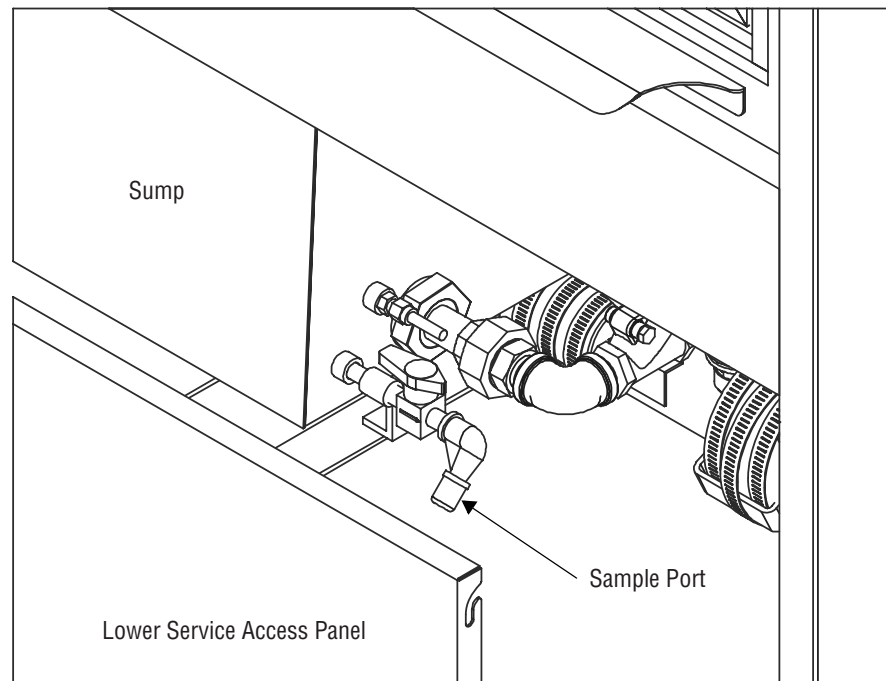

Figure 5-9. Sample Port

5.10 Programming Values With Access Code Enabled

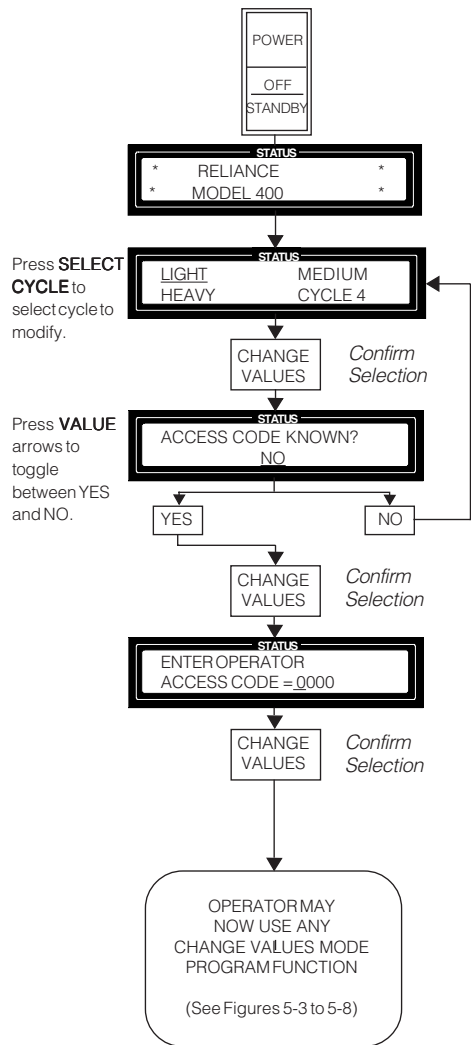

Figure 5-10. Change Values Mode – Programming With Access Code Enabled



Access code feature is used to prevent unauthorized changes to parameters of designated cycles and/or operating values. With this feature, access to cycle values may be selectively limited to authorized operators, depending on security needs of washer environment. When access code is enabled, only authorized operators can change operating values regardless of locked out cycles.

The following procedure and flowchart (see Figure 5-10) provide examples of how to access Change Values mode when the access code feature is enabled.

1. Set **POWER/OFF-STANDBY** switch, located behind printer door, to **POWER**. Unit name temporarily appears on screen, then screen displays first Cycle menu:

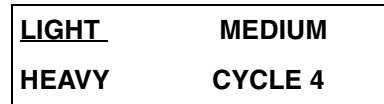

— indicates flashing position

NOTE: To scroll through available Cycle menus, press **CYCLE MENU** touch pad.

2. Press **CHANGE VALUES** touch pad to confirm cycle selection. Display shows:



— indicates flashing position

Press **CURSOR** arrows (left or right) to toggle between YES and NO.

3. Press **CHANGE VALUES** touch pad to confirm answer selection. If YES, following screen appears:

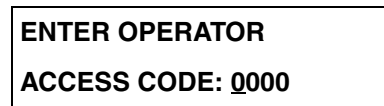

— indicates flashing position

To enter correct access code, press **CURSOR** arrows (left or right) to select position and **VALUE** arrows (up or down) to select desired number (0-9). Access code is entered as a four-digit number from 0000 to 9999.

NOTE: If incorrect access code is entered, display shows **ACCESS DENIED!**, then display automatically returns to first Cycle menu.

4. Once correct access code is entered, press **CHANGE VALUES** touch pad to confirm and access Change Values mode. See Figures 5-3 to 5-8 for flowcharts of available programming functions.

5.11 Review Cycle Values

Each cycle program may be reviewed by accessing Review mode when a cycle is not in progress. Review mode allows operator to view current settings of each programmable treatment value for the specific cycle selected.



1. Press **CYCLE MENU** touch pad until desired Cycle menu appears on screen:

<u>LIGHT</u>	MEDIUM
HEAVY	CYCLE 4

___ indicates flashing position



2. Press **SELECT CYCLE** touch pad until desired cycle name flashes:

LIGHT	<u>MEDIUM</u>
HEAVY	CYCLE 4

___ indicates flashing position



3. Press **REVIEW CYCLE** touch pad to access Review mode and view first treatment value programmed for selected cycle:

PRE-WASH1
RECIRC. TIME = <u>XX:XX</u>

___ indicates flashing position



4. Continue to press **REVIEW CYCLE** touch pad to sequentially view each treatment value programmed for selected cycle (for example, value for optional pure water tank shown):

PURE W. 1
NON-REC. TIME = <u>00:10</u>

___ indicates flashing position



5. Press **REVIEW CYCLE** touch pad until printout message appears on screen:

PRINT CYCLE VALUES?
REVIEW = YES STOP = NO



6. To generate a printout of viewed cycle treatments and values, press **REVIEW CYCLE** touch pad. Control exits Review mode and display screen returns to selected Cycle menu:

LIGHT	<u>MEDIUM</u>
HEAVY	CYCLE 4

___ indicates flashing position

and printer records:

```
=====
=  CYCLE PROGRAM REVIEW  =
=  CYCLE - MEDIUM      =
=====
REVIEW TIME           8:46:38A
REVIEW DATE           99/03/09
UNIT NUMBER           0000000000
PRE-WASH1
RECIRC. TIME =        1:00
WATER TEMP. =        COLD
PUMP1 WASH1
RECIRC. TIME =        4:00
HEATED AT =          150.0F
RINSE 1
RECIRC. TIME =        1:00
WATER TEMP. =        HOT
```



7. To bypass printout option, press **STOP/RESET** touch pad. Control exits Review mode and display screen returns to selected Cycle menu:

LIGHT	<u>MEDIUM</u>
HEAVY	CYCLE 4

__ indicates flashing position



IMPORTANT: A listing of the *Safety Precautions* to be observed when operating and servicing this glassware washer can be found in *SECTION 1* of this manual. Do not operate the equipment until you have become familiar with this information.

6.1 General



WARNING—PERSONAL INJURY AND/OR EQUIPMENT DAMAGE HAZARD:

- Regularly scheduled preventive maintenance is required for safe and reliable operation of this equipment. Contact STERIS to schedule preventive maintenance.
- Repairs and adjustments to this equipment must be made only by STERIS or STERIS-trained service personnel. Repairs and adjustments performed by unqualified personnel or installation of unauthorized parts could cause personal injury, result in improper equipment performance, void the warranty or result in costly damage. Contact STERIS regarding service options.

The sample preventive maintenance guide (**Table 6-1**) included in this section should be used as a guideline for determining the frequency of maintenance. This proves useful in helping ensure proper maintenance of your glassware washer.

Maintenance procedures described in this section must be performed as required at the suggested frequency. Indicated frequencies are minimums and can be changed if glassware washer use warrants.

If a problem occurs, refer to *SECTION 7, TROUBLESHOOTING*.

Refer to the *Maintenance Manual* (P764330-580) for complete replacement parts list.

6.2 Preventive Maintenance

The following guide should be followed to properly maintain the glassware washer. Some procedures should be carried out only by qualified service technicians. These procedures are noted by a star (*). Contact STERIS when service is required.

NOTE: Preventive Maintenance is not covered under warranty.

Table 6-1. Preventive Maintenance Guide

Recommended frequency of inspection is indicated in the right column. Usage and utility conditions may require more or less frequent inspections.		Suggested Frequency
1.0	PREPARATION FOR PREVENTIVE MAINTENANCE	
1.1	Discuss equipment operation with department personnel.	6 X/year
1.2	Inspect printouts for signs of trouble.	6 X/year
1.3	When required by procedure, shut off all building services and drain all lines. Always follow local occupational health and safety regulations, as well as electric and plumbing codes.	As required
2.0	EAGLE® 3000 STAGE 3 CONTROL SYSTEM	
2.1	Inspect printer for proper operation.	6 X/year
2.2	Inspect for proper operation of touch panel. Verify all touch pads. If faulty, call STERIS.*	6 X/year
2.3	Verify proper date and time are displayed; if not, reset.	6 X/year
2.4	Verify paper take up is working properly.	6 X/year
2.5	Verify printout for darkness, missing dots, etc.	3 X/year
2.6	Verify buzzer on control PC board is functioning properly.	6 X/year
3.0	DOOR ASSEMBLY	
3.1	Inspect door for ease of operation while a cycle is in progress. If faulty, call STERIS.*	3 X/year
3.2	Inspect door cable and pulleys. Replace if necessary.*	6 X/year
3.3	Verify condition and operation of door limit switch.*	6 X/year
3.4	Verify condition and operation of obstruction proximity sensor on top of door.*	6 X/year
3.5	Replace door limit switch bottom spring.*	1 X/year
4.0	CHAMBER COMPONENTS	
4.1	Inspect rotary spray arm assemblies for free movement and no clogged holes (see SECTION 6.4).	6 X/year
4.2	Verify bushings are in good condition and properly installed over and under rotary spray arm hub (see SECTION 6.4).	3 X/year
4.3	Clean debris screens in wash chamber (see SECTION 6.3).	6 X/year
4.4	Remove hard water deposits from interior of chamber (use DESCALER cycle; see SECTION 6.5.1).	6 X/year

*Contact STERIS for this service. Preventive Maintenance is not covered under warranty.

Table 6-1. Preventive Maintenance Guide (Cont'd)

Recommended frequency of inspection is indicated in the right column. Usage and utility conditions may require more or less frequent inspections.		Suggested Frequency
4.5	Verify proper water level and temperature.*	3 X/year
4.6	Verify piping system for leaks. Repair if necessary.*	6 X/year
4.7	Verify condition of sliding guides. Replace if necessary.*	3 X/year
5.0	SUPPLY-LINE STRAINERS	
	Inspect strainers for debris. Clean as necessary (see <i>SECTION 6.5.2</i>).	6 X/year
6.0	CHEMICALS AND INJECTION PUMPS	
6.1	Verify suction tube is not clogged, cracked or distorted. If damaged, call STERIS.*	6 X/year
6.2	Inspect and lubricate squeeze tubes. Replace if necessary (see <i>SECTION 6.7</i>).	6 X/year
6.3	Verify amount of chemical product injected. Adjust if necessary.	3 X/year
6.4	Lubricate pump roller (see <i>SECTION 6.7</i>).	6 X/year
7.0	COMPRESSOR	
	Verify intake filter and mufflers. Change if necessary.*	2 X/year
8.0	PROTECTIVE GROUND TERMINAL*	
	Verify protective conductor at equipment terminal and verify if connection is well secured inside terminal with proper torque equipment. Torque requirement for supply conductor terminals for steam heated units (L1-L2-L3- N) is: 7.1 - 8.9 lb/in (0.8 - 1.0 N•m) and for electric heated units (L1-L2-L3- N) is: 7.1 - 8.9 lb/in (0.8 - 1.0 N•m); for steam- and electric-heated units, protective conductor terminal is: 20 lb/in (2.2 N•m).*	1 X/year
9.0	FINAL TEST	
9.1	Clean dirt and lint from components. Verify all wiring, terminals and socket connections for damage or fraying.	6 X/year
9.2	Verify glassware washer has proper labels (caution, warning, etc.).	6 X/year
9.3	Install any panel or cover removed during inspection.	6 X/year
9.4	Test glassware washer operation.	6 X/year

*Contact STERIS for this service. Preventive Maintenance is not covered under warranty.

6.3 Daily Cleaning



WARNING—SLIPPING HAZARD: To prevent slips, keep floors dry. Promptly clean up any spills or drippage. For spills or drippage of detergents or other chemicals, follow safety precautions and handling procedures set forth on detergent or chemical label and/or Material Safety Data Sheet (MSDS).

1. After last cycle of day, allow unit to cool. Then, remove and clean debris screens in bottom of wash chamber and suction filter at bottom of sump. Always clean screens while they are still wet, before foreign matter dries.
2. Remove riser valve and inspect for debris. Brush and rinse under tap water if necessary.

6.4 Weekly Cleaning



WARNING—SLIPPING HAZARD: To prevent slips, keep floors dry. Promptly clean up any spills or drippage. For spills or drippage of detergents or other chemicals, follow safety precautions and handling procedures set forth on detergent or chemical label and/or Material Safety Data Sheet (MSDS).

On a weekly basis, perform the following routine cleaning procedures:

1. Clean washer exterior as follows: Using a general cleaner for general stains, a stainless-steel stain remover for stubborn stains and a stainless-steel polish to keep equipment looking like new.
 - a. Using a damp cloth or sponge, apply cleaner in a back-and-forth motion, rubbing in same direction as surface grain.
 - b. Thoroughly wipe off cleaner.
 - c. Polish surface with a clean, dry, lint-free cloth.
2. Wash chamber interior with a moderately alkaline detergent solution. Rinse with tap water and dry with a lint-free cloth.

NOTE: If interior is stained, use a general cleaner to remove general stains, or a stainless-steel stain remover for stubborn stains. Using a damp cloth or sponge, apply cleaner in a back-and-forth motion, rubbing in same direction as surface grain. Thoroughly wipe off cleaner and polish with a clean, dry, lint-free cloth.

3. Clean wash chamber rotary spray arm assemblies as follows:
 - a. Remove rotary spray holder from top of wash chamber.

NOTE: Before removing rotary spray holder, note the following:

- 1) *There are two loose bushings, one under and one over rotary spray hub. When lowering rotary spray assembly, bushings fall. Ensure to hold on to bushings while removing rotary spray assembly.*
- 2) *Do not remove spray arms from rotary spray arm hub.*
- b. Rinse each spray arm assembly under running water to clean out sediment.
- c. Use a fine wire (approximately wire gauge of a paper clip) to clean sediment from spray nozzles. Rinse under running water.
- d. Place bushings on rotary spray arm hub and reattach spray arm assembly to top of wash chamber.



CAUTION – POSSIBLE EQUIPMENT DAMAGE: Use nonabrasive cleaners when cleaning unit. Follow directions on containers and rub in a back-and-forth motion (in same direction as surface grain). Abrasive cleaners will damage stainless steel. Cleaners rubbed in a circular motion or applied with a wire brush or steel wool on door and chamber assemblies can be harmful to stainless steel. Do not use these cleaners on painted surfaces.

- Clean rotary spray arms on accessories in same way as chamber spray arms.

6.5 Monthly Cleaning

6.5.1 Remove Hard Water Deposits

WARNING – CHEMICAL BURN AND/OR EYE INJURY HAZARD:

- Detergents are caustic and can cause adverse effects to exposed tissues. Do not get in eyes, on skin or attempt to swallow. Read and follow the precautions and instructions on the detergent label and in the Material Safety Data Sheet (MSDS) prior to handling the detergent, refilling the detergent container or servicing the detergent injection pump and lines. Wear appropriate Personal Protective Equipment (PPE) when handling the detergent or servicing the detergent injection pump and lines.
- Wear appropriate Personal Protective Equipment (PPE) when using a descaling product. Avoid contact with the eyes or skin. If a descaling product spills or splashes on you, flush the affected area with water for 15 minutes. If swallowed, DO NOT induce vomiting. Administer an alkali with plenty of water. Seek medical attention immediately.

CAUTION – POSSIBLE EQUIPMENT DAMAGE: When choosing a detergent, select one with a low-chloride content. Detergents with a high-chloride content must not be used, as such detergents may harm stainless steel.

NOTE: Depending on hardness of water being used, it may be necessary to remove hard water deposits more often. Remove deposits from chamber and accessories whenever deposits become visible.

Remove hard water deposits from chamber and loading accessories as follows, using DESCALER cycle especially designed for this purpose:

- Place empty rack in wash chamber over manifold connector.
- Press **CYCLE MENU** touch pad to scroll to appropriate Cycle menu.
- Press **SELECT CYCLE** touch pad to select DESCALER cycle. Display shows:

CYCLE 9	CYCLE 10
DESCALER	PRIME

— indicates flashing position

- Press **CYCLE/START** touch pad to confirm DESCALER cycle selection. Display shows:

PRESS START TO PROCESS - DESCALER
--

- Press **CYCLE/START** touch pad to start DESCALER cycle. Display shows:

OPEN LOAD DOOR AND ADD DETERGENT

*NOTE: If **CYCLE/START** touch pad is not pressed within five seconds, display returns to main Cycle menu.*

- Open chamber door and pour 25 oz (740 mL) of descaling liquid into wash chamber. Display shows:

PLEASE CLOSE DOOR TO START DESCALER
--

- Close door. Press **CYCLE/START** touch pad to start DESCALER cycle.
- At completion of cycle, open door and allow unit to air dry.
- Verify debris screens in bottom of sump for debris. If debris is present, rinse filters under running water to clean.

6.5.2 Clean Building Supply-Line Strainers

 **WARNING – BURN HAZARD:** Allow piping to cool before inspecting and/or cleaning supply-line strainers.

NOTE: Piping tools are required. Contact facility maintenance technician for this procedure.

Clean building supply-line strainers as follows:

1. Position building electrical disconnect switch (circuit breaker) to OFF position.
2. Close building supply-lines: hot water, cold water (if option applies), pure water and steam (if option applies).
3. Position **power** switch (located under load side control) to OFF.
4. Unlock and open lower access doors.
5. Remove and clean strainers under running water.
6. Reinstall strainers.
7. Close and lock lower access doors.
8. Open building supply lines.
9. Restore power to unit.

6.6 Chemical Container Replacement

 **WARNING—CHEMICAL BURN AND/OR EYE INJURY HAZARD:** Detergents are caustic and can cause adverse effects to exposed tissues. Do not get in eyes, on skin or attempt to swallow. Read and follow the precautions and instructions on the detergent label and in the Material Safety Data Sheet (MSDS) prior to handling the detergent, refilling the detergent container or servicing the detergent injection pump and lines. Wear appropriate Personal Protective Equipment (PPE) whenever handling the detergent or servicing the detergent injection pump and lines.

 **CAUTION – POSSIBLE EQUIPMENT DAMAGE:** When choosing a detergent, select one with a low-chloride content. Detergents with a high-chloride content must not be used, as such detergents may harm stainless steel.

NOTE: For cleaning and descaling products, note the following:

- 1) *Contact STERIS for information on specific cleaning and descaling products recommended for use with this equipment.*
 - 2) *Always use a non-foaming detergent for effective cleaning and proper pump operation. Detergents with a high chloride content should not be used, as chlorides are harmful to stainless steel. Refer to detergent specifications in SECTION 2.3, DETERGENTS AND CHEMICAL ADDITIVES SPECIFICATIONS, and follow detergent manufacturer's recommendations for amount of detergent to be used.*
1. If detergent is low or has run out, install a new container.
 2. Place low level sensor upright in container (refer to Figure 4-1).
 3. Insert squeeze/suction tube into new container.
 4. Refer to *SECTION 4.2, PRIMING PROCEDURE*, to fill tubing with detergent.

IMPORTANT: *DO NOT insert suction tube into container without verifying it is for the proper application (refer to SECTION 2.3, DETERGENTS AND CHEMICAL ADDITIVES SPECIFICATIONS, for details).*

6.7 Inspect and Lubricate Peristaltic Injection Pump Squeeze Tubes



WARNING—CHEMICAL BURN AND/OR EYE INJURY HAZARD: Detergents are caustic and can cause adverse effects to exposed tissues. Do not get in eyes, on skin or attempt to swallow. Read and follow the precautions and instructions on the detergent label and in the Material Safety Data Sheet (MSDS) prior to handling the detergent, refilling the detergent container or servicing the detergent injection pump and lines. Wear appropriate Personal Protective Equipment (PPE) whenever handling the detergent or servicing the detergent injection pump and lines.



CAUTION – POSSIBLE EQUIPMENT DAMAGE: Always use a silicone lubricant to lubricate squeeze tubes. Petroleum-based lubricants, such as Vaseline^{®1} or grease, will cause squeeze tubes to melt.

Each month, lubricate and inspect injection pump squeeze tube(s) as follows:

1. Use silicone lubricant (P117950-599) to lubricate section of squeeze tube in contact with pump(s).
2. Verify squeeze tube(s) for any leaks or signs of wear. If necessary, replace tube as follows:
 - a. If unit is ON, position **power** switch to OFF.
 - b. Remove upper service access panel. Injection pumps are located on left, on load side.
 - c. Remove clamps and disconnect squeeze tube ends from suction and feed lines.
 - d. Remove screws attaching injection pump faceplate to injection pump head. Lift faceplate away from pump head.
 - e. To remove squeeze tube from pump head, pull out tube by one end. Discard tube.
 - f. Clean all pump surfaces.
 - g. Insert one end of new tube into pump head and rotate roller block manually.
 - h. Liberally spread silicone lubricant (P117950-599) over rollers in roller block and all tubing surfaces in contact with pump head.
 - i. Return faceplate to pump head and fasten with previously removed screws.
 - j. Connect ends of tube to suction and feed lines. Attach clamps to both lines.
 - k. Reinstall upper access panel.
 - l. Refer to *SECTION 4.2, PRIMING PROCEDURE*, to fill tubing with chemical.
 - m. Position **power** switch to ON, initiate a cycle and verify squeeze tube operation.

¹ Vaseline is a trademark of Chesebrough Pond's Incorporated.

6.8 Verify Power Doors



WARNING – BURN HAZARD: Wear appropriate Personal Protective Equipment (PPE) and open door slowly if it is necessary to open during a cycle. Hot water/steam may be sprayed through door opening when verifying automatic stop while washer is operating.

Verify operation of vertical sliding doors. Verify door operates smoothly. Refer to *SECTION 7, TROUBLESHOOTING*, if door does not operate smoothly.

Verify operation of each door safety switch as follows:

1. Wearing appropriate Personal Protective Equipment (PPE), attempt to initiate a cycle with load side door open.
2. Close door and start a cycle. Wearing appropriate Personal Protective Equipment (PPE), slowly open door to verify operation of automatic stop.
3. Repeat for unload side door.

6.9 Changing Printer Paper Roll

See Figure 6-1.

NOTE: Do not operate printer without paper.

1. Open printer door.
2. Grasp remaining paper and pull it upward and out of printer.
3. Remove take-up spindle from its drive mechanism by pulling it to left.
4. Remove paper roll from take-up spindle and set empty take-up spindle aside.
5. Lower platen and remove lower paper spindle by pulling it straight forward.
6. Place new paper roll onto lower spindle with paper feeding downward from back of paper roll.

NOTE: Verify paper roll is positioned correctly. Thermal printer does not print if paper roll is inserted backward. Use only STERIS thermal paper (P129359-008). Damage to printer mechanisms can occur if paper of different width or thickness is used.

7. Place lower spindle (with new paper roll) back into position by pressing from front until it snaps into place.
8. Pull 4 or 5 inches (10 to 13 cm) of paper out from roll and tear corners off end.
9. Slide tab of paper roll into printer from back (with platen still in down position) until it exits from front of printer.
10. Grasp tab of paper, pull up 10 to 12 inches (25 to 30 cm) of paper and feed this paper through opening in platen.
11. Insert tab of new paper roll into slot of take-up spindle and rotate spindle to secure paper in slot.
12. Raise platen back up into position and snap in place under catch.

13. Press take-up spindle back onto drive mechanism and allow motor to rotate spindle to verify paper is secured to take-up roll.
14. Set **POWER/OFF-STANDBY** switch to **OFF-STANDBY** position; then, to **POWER** position to verify paper is correctly routed into mechanism and printer prints. Printer does not print if thermal paper was placed on wrong side.
15. Close printer door.

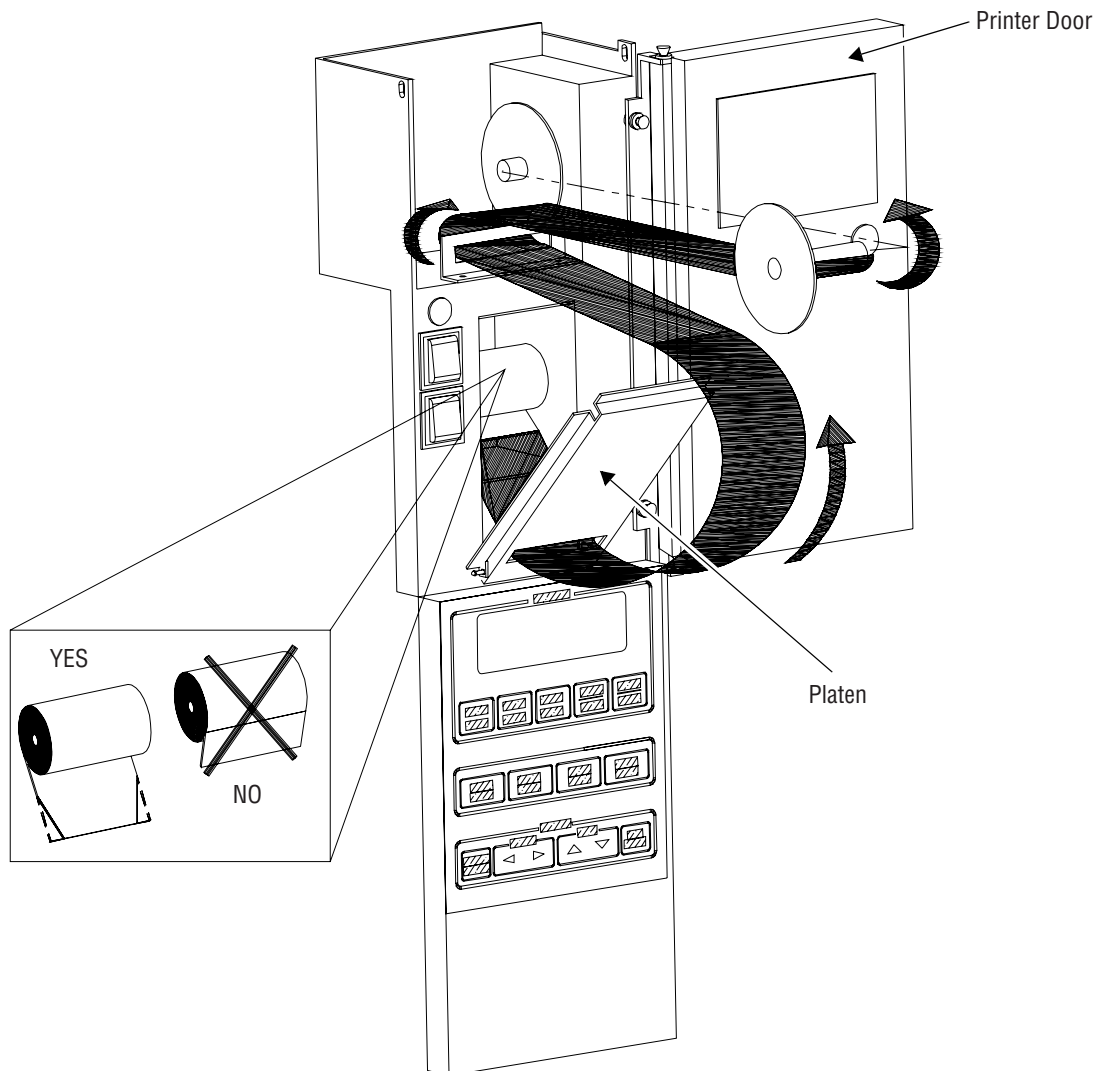

Figure 6-1. Changing Printer Paper Roll

6.10 Storing Thermal Paper

Thermal paper is subject to fading with time, humidity and exposure to light.

It is the manufacturer's recommendation that thermal paper be stored in a dark place with an average ambient temperature of less than 77°F (25°C) and a relative humidity less than 65%. Under these conditions, paper remains readable for at least five years. It is recommended that if the printed data is to be retained for periods of time longer than five years, an additional photocopy should be made for record retention. In any case, a duplicate set of records should be maintained in the files of the engineering or maintenance departments.

Thermal paper begins to develop color at about 158°F (70°C), however, under humid conditions, it might begin to develop at an accelerated rate. If stored for 24 hours at 140°F (60°C), the paper shows some signs of development. It also shows signs of development if stored for 24 hours at 113°F (45°C) and a relative humidity of 90%.

Do not store thermal paper next to other chemically treated papers – such as pressure sensitive paper or other types of recording round charts – as this may cause fading in print. If thermal paper is to be stored in the same area, always ensure it and other chemically treated papers are kept in separate envelopes.

Thermal paper discolors when exposed to direct sunlight.



IMPORTANT: A listing of the Safety Precautions to be observed when operating and servicing this glassware washer can be found in SECTION 1 of this manual. Do not operate the equipment until you have become familiar with this information.



WARNING—PERSONAL INJURY AND/OR EQUIPMENT DAMAGE HAZARD: Repairs and adjustments to this equipment must be made only by STERIS or STERIS-trained service personnel. Repairs and adjustments performed by unqualified personnel or installation of unauthorized parts could cause personal injury, result in improper equipment performance, void the warranty or result in costly damage. Contact STERIS regarding service options.



WARNING – ELECTRIC SHOCK AND/OR BURN HAZARD:

- STERIS strongly recommends service be performed only by STERIS or STERIS-trained service personnel. Service personnel must disconnect all utilities to unit before servicing. No one should service unit unless all utilities have been properly locked out. Always follow local electrical codes and safety-related work practices.
- Fasteners and star washers are used to ensure protective bonding continuity. Always reinstall any star washer which may have been removed during installation or servicing.

This section describes the types of washer malfunctions which may occur, and indicates probable causes and corrective actions.

If unable to correct problem with use of Troubleshooting Charts (**Table 7-1** and **Table 7-2**), or if a problem occurs that is not described on the charts, please call STERIS. Service charges may be incurred. Consult your warranty for details. **NEVER PERMIT UNQUALIFIED PERSONS TO SERVICE THE GLASSWARE WASHER.**

Table Descriptions:

Table 7-1 – Problems where NO alarm screen and printout occur.

Table 7-2 – Problems where alarm screen and/or printout occur.



WARNING – SLIPPING HAZARD: To prevent slips, keep floors dry. Promptly clean up any spills or drippage. For spills or drippage of detergents or other chemicals, follow safety precautions and handling procedures set forth on detergent or chemical label and/or Material Safety Data Sheet (MSDS).

Table 7-1. Troubleshooting Chart – No Alarm Screen and Printout

PROBLEM	POSSIBLE CAUSE AND CORRECTION
1. Interior light does not turn on.	<ol style="list-style-type: none"> 1. POWER-OFF/STANDBY switch in OFF/STANDBY position. Position to POWER. 2. Unit is still in Service mode. Switch washer to Automatic mode before starting processing, by pressing EXTEND CYCLE touch pad. 3. Interior light bulb is burned out. Replace bulb. 4. Open fuse on connector PC board inside console assembly. Call STERIS.*
2. If washer is equipped with double door, unload door fails to open.	Safety interlock feature engaged. Unload door does not open until washer has run one complete cycle.
3. Display is locked; pressing touch pad has no effect.	<ol style="list-style-type: none"> 1. Multiple alarm conditions have occurred simultaneously; position POWER-OFF/STANDBY switch to OFF/STANDBY, then back to POWER. 2. If condition reoccurs, call STERIS.*
4. Screen indicates "SERVICE TEST" when POWER-OFF/STANDBY switch is positioned to POWER.	<ol style="list-style-type: none"> 1. Washer in Service mode. Switch washer to Automatic mode by pressing EXTEND CYCLE touch pad. 2. Call STERIS.*
5. Cycle does not start when CYCLE/START touch pad is pressed or Pump does not start during a treatment.	<ol style="list-style-type: none"> 1. Chamber door open. Close door and press CYCLE/START touch pad. 2. Call STERIS.*
6. Generated printout is light or blank, or parts of characters are missing on generated printout.	<ol style="list-style-type: none"> 1. Printer paper installed backward. Reinstall paper roll with paper feeding downward from the back of the roll (refer to SECTION 6.9). 2. Incorrect printer paper used. Use recommended products. Use only STERIS thermal paper (P129359-008). 3. Printer head is dirty. Call STERIS.* 4. Printer is defective. Call STERIS.* 5. Printer PC board is defective. Call STERIS.*
7. Insufficient or no water entering chamber through spray system, manifold and/or bottom rotary spray arms.	<ol style="list-style-type: none"> 1. Accessory header(s) incorrectly positioned in chamber. Ensure each accessory header is positioned directly over a manifold connector. 2. Rotary spray arms clogged. Clean spray arms (refer to SECTION 6.4). 3. Chamber debris screens clogged. Clean screens (refer to SECTION 6.3). 4. If condition reoccurs, call STERIS.*
8. Water leaks from unit.	<ol style="list-style-type: none"> 1. Tighten all clamps and connections. 2. If condition reoccurs, call STERIS.*

*Service charges may be incurred. Consult your warranty for details.

Table 7-1. Troubleshooting Chart – No Alarm Screen and Printout

PROBLEM	POSSIBLE CAUSE AND CORRECTION
9. Pump starts before appropriate chamber water level is reached.	<ol style="list-style-type: none"> 1. Verify water level sensor float moves freely. Clean as necessary. 2. If condition reoccurs, call STERIS.*
10. Too much water entering chamber during treatment. Water going to overflow drain.	<ol style="list-style-type: none"> 1. Verify water level sensor float moves freely. Clean as necessary. 2. If condition reoccurs, call STERIS.*
11. Foam in chamber.	<ol style="list-style-type: none"> 1. Wrong type of detergent. Refer to detergent specifications in SECTION 2.3, and follow detergent manufacturer's recommendations for amount of detergent to be used. 2. Too much chemical is injected during treatment. Verify chemical injection rate in Automatic mode. 3. If condition reoccurs, call STERIS.*
12. Insufficient or no water entering chamber during treatment.	<ol style="list-style-type: none"> 1. Supply valves not fully open. Open building and washer supply valves. Supply line pressure must be as specified on equipment drawing (122992-953 for Reliance 400 or 122993-554 for Reliance 500). 2. If condition reoccurs, call STERIS.*
13. Chamber does not drain completely.	<ol style="list-style-type: none"> 1. Chamber debris screens clogged. Clean screens (refer to SECTION 6.3). 2. Drain line plugged. Flush out drain line. 3. Building piping obstructed. Verify piping and flush out if necessary. 4. If condition reoccurs, call STERIS.*
14. Loads come out dirty.	<ol style="list-style-type: none"> 1. Empty chemical supply. Install new supply as explained in SECTION 6.6. 2. Wrong type of detergent used. Refer to detergent specifications in SECTION 2.3 and follow detergent manufacturer's recommendations for amount of detergent to be used. 3. Rotary spray arms clogged. Clean spray arms (refer to SECTION 6.4). 4. Call STERIS.*
15. Pump runs at low speed when Universal Loading Shelf installed.	<ol style="list-style-type: none"> 1. Universal loading shelf misplaced. Remove universal loading shelf and replace it correctly (refer to SECTION 4.4). 2. If condition reoccurs, call STERIS.*
16. Treatment stops for no apparent reason.	<ol style="list-style-type: none"> 1. Chamber door(s) not fully closed. Close securely. 2. If condition reoccurs, call STERIS.*

*Service charges may be incurred. Consult your warranty for details.

Table 7-2. Troubleshooting Chart – Alarm Screen and/or Printout

PROBLEM	POSSIBLE CAUSE AND CORRECTION
<p>1. STOP/RESET touch pad was pressed. Display shows: STOP WAS PRESSED PRESS START TO RESUM</p> <p>Printout message: STOP PRESSED HH:MM:SS</p>	<p>Press ALARM REPLY touch pad to silence alarm buzzer. Press CYCLE/START touch pad to resume operation, or press STOP/RESET touch pad again to abort cycle operation.</p>
<p>2. Chamber sump is taking too long to fill with water. Alarm sounds, and display shows: SUMP TOO LONG IN FILL</p> <p>Printout message: ALARM: SUMP HH:MM:SS TOO LONG IN FILL</p>	<p>1. Supply valves closed. Press ALARM REPLY touch pad to silence alarm buzzer. Open building and washer supply valves and press CYCLE/START touch pad to resume operation.</p> <p>2. If condition reoccurs, call STERIS.*</p>
<p>3. Chamber sump is taking too long to drain. Alarm sounds, and display shows: SUMP TOO LONG IN DRAIN</p> <p>Printout message: ALARM: SUMP HH:MM:SS TOO LONG IN DRAIN</p>	<p>1. Water level sensor stuck or obstructed. Press ALARM REPLY touch pad to silence alarm buzzer. Verify water level sensor, clean if necessary and press CYCLE/START touch pad to resume operation.</p> <p>2. Air supply valves closed or air pressure is below specification. Press ALARM REPLY touch pad to silence alarm buzzer. Open building and washer air supply valves and press CYCLE/START touch pad to resume operation.</p> <p>3. If condition reoccurs, call STERIS.*</p>
<p>4. Water temperature in chamber sump is below the programmed temperature. Alarm sounds, and display shows: ALARM: SUMP FAILED TO REACH SET TEMP.</p> <p>Printout message: ALARM: SUMP HH:MM:SS FAILED TO REACH SET TEMP.</p>	<p>1. Steam supply valves closed. Press ALARM REPLY touch pad to silence alarm buzzer. Open building and washer steam supply valves and press CYCLE/START touch pad to resume operation.</p> <p>2. Excess condensate in building supply lines. Press ALARM REPLY touch pad to silence alarm buzzer. Verify steam traps in facility supply lines.</p> <p>3. If conditions reoccurs, call STERIS.*</p>

*Service charges may be incurred. Consult your warranty for details.

Table 7-2. Troubleshooting Chart – Alarm Screen and/or Printout

PROBLEM	POSSIBLE CAUSE AND CORRECTION
<p>5. Chamber sump RTD is detecting out-of-range temperatures. Alarm sounds, and display shows:</p> <p>ALARM: SUMP RTD DEFECTIVE</p> <p>Printout message: ALARM: SUMP RTD HH:MM:SS DEFECTIVE</p>	<p>1. RTD connector unplugged. Press ALARM REPLY touch pad to silence alarm buzzer. Verify RTD connection and press CYCLE/START touch pad to resume operation.</p> <p>2. If condition reoccurs, call STERIS.*</p>
<p>6. Chamber RTD detecting out-of-range temperature. Alarm sounds, and display shows:</p> <p>ALARM: SUMP WATER TEMP. TOO HIGH</p> <p>Printout message: ALARM: SUMP WATER HH:MM:SS TEMP. TOO HIGH</p>	<p>Press ALARM REPLY touch pad to silence alarm buzzer and call STERIS.*</p>
<p>7. If washer is equipped with heated pure water rinse option, water temperature in optional pure water storage tank is below the programmed temperature. Alarm sounds, and display shows:</p> <p>ALARM: PURE W. TANK FAILED TO REACH TEMP</p> <p>Printout message: ALARM:PURE WATER TANK HH:MM:SS FAILED TO REACH TEMP</p>	<p>1. Steam supply valve closed. Press ALARM REPLY touch pad to silence alarm buzzer. Open building and washer steam supply valves and press CYCLE/START touch pad to resume operation.</p> <p>2. Excess condensate in building supply lines. Press ALARM REPLY touch pad to silence alarm buzzer. Verify steam traps in facility supply lines.</p> <p>3. If condition reoccurs, call STERIS.*</p>

**Service charges may be incurred. Consult your warranty for details.*

Table 7-2. Troubleshooting Chart – Alarm Screen and/or Printout

PROBLEM	POSSIBLE CAUSE AND CORRECTION
<p>8. If washer is equipped with heated pure water rinse option, optional pure water tank RTD is detecting out-of-range temperatures. Alarm sounds, and display shows:</p> <p>ALARM: PW TANK RTD DEFECTIVE</p> <p>Printout message: ALARM: PW TANK RTD HH:MM:SS DEFECTIVE</p>	<ol style="list-style-type: none"> 1. RTD connector unplugged. Press ALARM REPLY touch pad to silence alarm buzzer. Verify RTD connection and press CYCLE/START touch pad to resume operation. 2. If condition reoccurs, call STERIS.*
<p>9. Purified water is taking too long to fill. Alarm sounds, and display shows:</p> <p>ALARM: PURE W. TOO LONG IN FILL</p> <p>Printout message: ALARM: PURE WATER HH:MM:SS TOO LONG IN FILL</p>	<ol style="list-style-type: none"> 1. Pure water supply valves closed. Press ALARM REPLY touch pad to silence alarm buzzer. Open building and washer pure water supply valves and press CYCLE/START touch pad to resume operation. 2. If condition reoccurs, call STERIS.*
<p>10. If washer is equipped with heated pure water rinse option, optional pure water tank RTD is detecting out-of-range temperatures. Alarm sounds, and display shows:</p> <p>ALARM: PURE WATER TEMP. TOO HIGH</p> <p>Printout message: ALARM: PURE WATER HH:MM:SS TEMP TOO HIGH</p>	<p>Press ALARM REPLY touch pad to silence alarm buzzer and call STERIS.*</p>

*Service charges may be incurred. Consult your warranty for details.

Table 7-2. Troubleshooting Chart – Alarm Screen and/or Printout

PROBLEM	POSSIBLE CAUSE AND CORRECTION
<p>11. Optional pure water tank level sensor still detects water after completion of pure water treatment. Alarm sounds, and display shows:</p> <p>ALARM: PURE W TANK DID NOT EMPTY</p> <p>Printout message: ALARM: PURE W TANK HH:MM:SS DID NOT EMPTY</p>	<ol style="list-style-type: none"> 1. Water level sensor stuck or obstructed. Press ALARM REPLY touch pad to silence alarm buzzer. Verify optional pure water tank level sensor, clean if necessary and press CYCLE/START touch pad to resume operation. 2. Pure water outlet valve stuck in closed position. Press ALARM REPLY touch pad to silence alarm buzzer. Verify pure water outlet valve, clean if necessary and press CYCLE/START touch pad to resume operation. 3. If condition reoccurs, call STERIS.*
<p>12. If washer is equipped with drying system option, dryer RTD is detecting out-of-range temperatures. Alarm sounds, and display shows:</p> <p>ALARM: DRYING RTD DEFECTIVE</p> <p>Printout message: ALARM: DRYING RTD HH:MM:SS DEFECTIVE</p>	<ol style="list-style-type: none"> 1. RTD connector unplugged. Press ALARM REPLY touch pad to silence alarm buzzer. Verify RTD connection and press CYCLE/START touch pad to resume operation. 2. If condition reoccurs, call STERIS.*
<p>13. If washer is equipped with drying system option, dryer RTD is detecting out-of-range temperatures. Alarm sounds, and display shows:</p> <p>ALARM: DRYING TEMP. TOO HIGH</p> <p>Printout message: ALARM: DRYING HH:MM:SS TEMP TOO HIGH</p>	<p>Press ALARM REPLY touch pad to silence alarm buzzer and call STERIS.*</p>
<p>14. Pump contactor overload tripped. Alarm sounds, and display shows:</p> <p>ALARM: MOTOR OVERLOADS TRIPPED</p> <p>Printout message: ALARM: MOTOR HH:MM:SS OVERLOADS TRIPPED</p>	<p>Press ALARM REPLY touch pad to silence alarm buzzer and call STERIS.*</p>

*Service charges may be incurred. Consult your warranty for details.

Table 7-2. Troubleshooting Chart – Alarm Screen and/or Printout

PROBLEM	POSSIBLE CAUSE AND CORRECTION
<p>15. Alarm sounds, and display shows: (CYCLE NAME) (WATER TYPE) CYCLE STOPPED</p> <p>Alternating with: ALARM: (PUMP NAME) DETERGENT EMPTY</p> <p>Printout message: ALARM: (PUMP NAME) HH:MM:SS DETERGENT EMPTY</p>	<ol style="list-style-type: none"> 1. Empty chemical container. Press ALARM REPLY touch pad to silence alarm buzzer. Install new supply and press CYCLE/START touch pad to resume operation (refer to <i>SECTION 6.6</i>). 2. Low level sensor out of container. Press ALARM REPLY touch pad to silence alarm buzzer. Insert level sensor in container and press CYCLE/START touch pad to resume operation (refer to <i>SECTION 6.6</i>). 3. If condition reoccurs, call STERIS.*
<p>16. Load side door was opened during cycle processing. Alarm sounds, and display shows: ALARM: LOAD DOOR OPEN DURING PROCESS</p> <p>Printout message: ALARM: LOAD DOOR OPEN HH:MM:SS DURING PROCESS</p>	<ol style="list-style-type: none"> 1. Press ALARM REPLY touch pad to silence alarm buzzer. Close load side door and press CYCLE/START touch pad to resume operation. 2. If condition reoccurs, call STERIS.*
<p>17. If washer is equipped with power door: load side door remains closed after DOOR OPEN touch pad was pressed. Alarm sounds, and display shows: ALARM: LOAD DOOR DID NOT OPEN</p> <p>Printout message: ALARM: LOAD DOOR HH:MM:SS DID NOT OPEN</p>	<ol style="list-style-type: none"> 1. Air supply valves are closed or air pressure is below specifications. Press ALARM REPLY touch pad to silence alarm buzzer. Open building and washer air supply valves and press DOOR OPEN touch pad on load side control panel to open door. 2. Load door stayed closed after DOOR OPEN was pressed. Proceed as follows: <ol style="list-style-type: none"> a. Press ALARM REPLY touch pad to silence buzzer. b. Press DOOR CLOSE touch pad. c. Press DOOR OPEN touch pad. d. If condition reoccurs, call STERIS.*

*Service charges may be incurred. Consult your warranty for details.

Table 7-2. Troubleshooting Chart – Alarm Screen and/or Printout

PROBLEM	POSSIBLE CAUSE AND CORRECTION
<p>18. If washer is equipped with power door: load side door remains open after DOOR CLOSE touch pad was pressed. Alarm sounds, and display shows:</p> <p>ALARM: LOAD DOOR DID NOT CLOSE</p> <p>Printout message: ALARM: LOAD DOOR HH:MM:SS DID NOT CLOSE</p>	<ol style="list-style-type: none"> 1. Air supply valves are closed or air pressure is below specifications. Press ALARM REPLY touch pad to silence alarm buzzer. Open building and washer air supply valves and press DOOR CLOSE touch pad on load side control panel to close door. 2. If condition reoccurs, call STERIS.*
<p>19. If washer is equipped with power double doors: unload side door was opened during cycle processing. Alarm sounds, and display shows:</p> <p>ALARM: UNLOAD DOOR OPEN DURING PROCESS</p> <p>Printout message: ALARM: UNLOAD DOOR HH:MM:SS OPEN DURING PROCESS</p>	<ol style="list-style-type: none"> 1. Press ALARM REPLY touch pad to silence alarm buzzer. Close unload side door and press CYCLE/START touch pad to resume operation. 2. If condition reoccurs, call STERIS.*
<p>20. If washer is equipped with power double doors: unload side door remains closed after DOOR OPEN touch was pressed. Alarm sounds, and display shows:</p> <p>ALARM: UNLOAD DOOR DID NOT OPEN</p> <p>Printout message: ALARM: UNLOAD DOOR HH:MM:SS DID NOT OPEN</p>	<ol style="list-style-type: none"> 1. Air supply valves are closed or air pressure is below specifications. Press ALARM REPLY touch pad to silence alarm buzzer. Open building and washer air supply valves and press DOOR OPEN touch pad on unload side control panel to open door. 2. If condition reoccurs, call STERIS.*

**Service charges may be incurred. Consult your warranty for details.*

Table 7-2. Troubleshooting Chart – Alarm Screen and/or Printout

PROBLEM	POSSIBLE CAUSE AND CORRECTION
<p>21. If washer is equipped with power double doors: unload side door remains open after DOOR CLOSE touch pad was pressed. Alarm sounds, and display shows:</p> <p>ALARM: UNLOAD DOOR DID NOT CLOSE</p> <p>Printout message: ALARM: UNLOAD DOOR HH:MM:SS DID NOT CLOSE</p>	<ol style="list-style-type: none"> 1. Air supply valves are closed or air pressure is below specifications. Press ALARM REPLY touch pad to silence alarm buzzer. Open building and washer air supply valves and press DOOR CLOSE touch pad on unload side control panel to close door. 2. If condition reoccurs, call STERIS.*
<p>22. Display shows:</p> <p>MAINTENANCE DUE CALL SERVICE...</p> <p>Printout message: MAINTENANCE DUE !</p>	<p>Call STERIS.*</p>
<p>23. If washer is equipped with power door(s): door safety switch detects an obstruction while door is closing. Alarm sounds, and display shows:</p> <p>ALARM: DOOR OBSTRUCTED</p> <p>Printout message: ALARM: DOOR OBSTRUCTED HH:MM:SS</p>	<ol style="list-style-type: none"> 1. Door movement obstructed. Press ALARM REPLY touch pad to silence alarm buzzer. Remove obstruction from doorway, press DOOR CLOSE touch pad and press CYCLE/START touch pad to resume operation. 2. Door safety switch failed, call STERIS.*
<p>24. Display is blank and printout message is:</p> <p>BOARD COMMUNICATION FAILURE 02</p>	<ol style="list-style-type: none"> 1. Communication between control board and I/O board has been interrupted. Verify control cable is tightly connected. To reset control, turn power switch to OFF, then back ON. 2. If condition reoccurs, call STERIS.*

*Service charges may be incurred. Consult your warranty for details.