

OPERATING INSTRUCTIONS

Amsco[®] Century[®] Gravity and Prevacuum Sterilizers

(11/13/06)

P129367-408

STERIS[®]



STERIS Mexico
Avenida Avante 790
Parque Industrial Guadalupe
Guadalupe, Nuevo Leon, Mexico C.P. 67190
www.steris.com

A WORD FROM STERIS CORPORATION

This manual contains important information on proper use of this sterilizer. All operators and department supervisors are urged to carefully review and become familiar with the warnings, cautions and instructions contained herein.

This sterilizer is specifically designed to process goods using only the cycles as specified in this manual. If there is any doubt about a specific material or product, contact the manufacturer of the product for the recommended sterilization technique.

STERIS carries a complete line of accessories for this unit to simplify, organize and assure sterility of the sterilization process. Instrument trays, pouches and biological/chemical monitoring systems are all available to fulfill your facility's processing needs. A STERIS representative will gladly review these with you.

Advisory

A summary of the *Safety Precautions* to be observed when operating and servicing this equipment can be found in Section 1 of this manual. Do not operate or service the equipment until you have become familiar with this information.

Any alteration of the sterilizer not authorized or performed by STERIS which could affect its operation will void the warranty, could adversely affect sterilization efficacy, could violate federal, state and local regulations and jeopardize your insurance coverage.

Service Information

A thorough preventive maintenance program is essential to safe and proper sterilizer operation. You are encouraged to contact STERIS concerning our Preventive Maintenance Agreement. Under terms of this agreement, preventive maintenance, adjustments, and replacement of worn parts are done on a scheduled basis to assure equipment performance at peak capability and to help avoid untimely or costly interruptions. STERIS maintains a nationwide staff of well-equipped, factory-trained technicians to provide this service, as well as expert repair services. Contact STERIS for details.

Indications for Use

The Amsco® Century® Steam Sterilizer is designed for efficient, sterilization of non-porous and porous, heat and moisture-stable materials used in healthcare facilities. The Century Steam Sterilizer is available in the following configurations:

16" x 16" x 26" Single Door Gravity	16" x 16" x 26" Single Door Prevacuum
16" x 16" x 26" Double Door Gravity	16" x 16" x 26" Double Door Prevacuum
20" x 20" x 38" Single Door Gravity	20" x 20" x 38" Single Door Prevacuum
20" x 20" x 38" Double Door Gravity	20" x 20" x 38" Double Door Prevacuum

The Amsco Century Steam Sterilizer is equipped with the following factory-programmed sterilization cycles and cycle values:

PREVACUUM CONFIGURATION

CYCLES	RECOMMENDED LOADS	STERILIZE TEMP.	STERILIZE TIME	DRY TIME
FLASH	Unwrapped Instrument tray with a single instrument.	270°F (132°C)	3.0 minutes	1.0 minute
FLASH	Unwrapped instrument tray with non-porous multiple instruments, maximum weight 17lbs.	270°F (132°C)	10 minutes	1.0 minute
EXPRESS	Single wrapped instrument tray with a single instrument. Non-porous goods only.	270°F (132°C)	4.0 minutes	3.0 minutes
PREVAC	Up to two double wrapped instrument trays, maximum weight 17 lbs. Up to six fabric packs.	270°F (132°C)	4.0 minutes	20 minutes ¹
PREVAC	Up to two double wrapped instrument trays, maximum weight 17 lbs.	275°F (135°C)	3.0 minutes	16 minutes

¹Five minute Dry Time can be used for processing a single fabric pack.

GRAVITY CONFIGURATION

CYCLES	RECOMMENDED LOADS	STERILIZE TEMP.	STERILIZE TIME	DRY TIME
FLASH	Unwrapped Instrument tray with a single instrument.	270°F (132°C)	3.0 minutes	1.0 minute
FLASH	Unwrapped instrument tray with non-porous multiple instruments, maximum weight 17lbs.	270°F (132°C)	10 minutes	1.0 minute
GRAVITY	Up to two double wrapped trays, maximum weight 17 lbs.	270°F (132°C)	15 minutes	30 minutes
GRAVITY	Up to six Fabric Packs.	250°F (121°C)	30 minutes ²	15 minutes

² A 270°F (132°C) cycle adjusted to 25 minute Sterilize Time can be used for processing fabric packs.

TABLE OF CONTENTS

Section	Title	Page
	A WORD FROM STERIS CORPORATION	i
1	SUMMARY OF SAFETY PRECAUTIONS	1-1
2	STERILIZATION TECHNIQUES	2-1
	2.1 General	2-1
	2.2 Special Information Regarding the Express Cycle	2-1
	2.2.1 Preparing Instruments for Express Cycle Sterilization	2-2
	2.2.2 Unloading	2-2
	2.3 Special Information Regarding The Flash Cycle	2-3
	2.4 Control Measures For Verifying Sterilization Process	2-4
	2.4.1 Biological Monitors	2-4
	2.4.2 Testing for Prevacuum Efficiency	2-4
	2.5 Dart (Bowie-Dick) Test	2-5
	2.6 Vacuum Leak Test	2-5
	2.7 Sterilization Process Recommendations	2-5
3	COMPONENT IDENTIFICATION	3-1
	3.1 General	3-2
	3.2 Main Sterilizer and Cycle Controls	3-2
	3.3 Control Displays	3-3
	3.4 Alarm Displays	3-4
	3.5 Operating End Control Panel	3-5
	3.6 Cycle Selection Touch Screen Pads	3-6
	3.6.1 Values Touch Screen Pads	3-6
	3.6.2 Abort Touch Screen Pad	3-7
	3.7 Printer	3-7
	3.8 Printouts	3-8
	3.9 Power Door Operation	3-9
	3.10 Emergency Door Opening Procedure	3-10
	3.11 Optional Electric Steam Generator	3-11
4	STERILIZER OPERATION.....	4-1
	4.1 Before Operating the Sterilizer	4-1
	4.2 Preparing Loads for Sterilization Cycles	4-2
	4.3 Guidelines for Placement of Various Loads	4-3
	4.4 Unloading the Sterilizer	4-4
	4.5 Loading Car Instructions: Loading	4-5
	4.6 Loading Car Instructions: Unloading	4-6
	4.7 Loading/Unloading Sterilizer Equipped With Rack and Shelves	4-6
	4.8 Sterilizer (Factory) Cycle Settings	4-7
	4.9 270°F Flash Cycle	4-8
	4.10 Gravity Cycle	4-11
	4.11 270°F Express Cycle	4-14
	4.12 270°F Prevac Cycle	4-17
	4.13 275°F Prevac Cycle	4-20
	4.14 DART (Bowie-Dick) Test (Prevacuum Sterilizer only)	4-23
	4.15 Vacuum Leak Test (Prevacuum Sterilizer only)	4-25

Section 4 Contents Continued On Next Page

TABLE OF CONTENTS (Cont'd)

Section	Title	Page
4.16	Optional Liquid Cycle	4-27
4.17	Sterilization Techniques for Optional Liquid Cycle	4-30
4.18	Recommendations for Sterilizing Liquids	4-31
4.19	Aborting Cycles	4-32
4.20	Cycle Graphs	4-33
5	STERILIZER CYCLES AND CYCLE VALUES	5-1
5.1	Sterilizer (Factory) Cycle Settings	5-2
5.2	Change Values	5-3
5.3	Change Cycle Values	5-4
5.3.1	Overview	5-4
5.3.2	Step by Step	5-4
5.4	Adjusting Sterilize Time And Dry Time	5-7
5.5	Change Time and Date	5-8
5.6	Change Machine Setup	5-10
5.7	Access Code	5-11
5.8	Lockout	5-13
5.9	Utilities Control	5-14
5.10	Language	5-17
5.11	Machine Number	5-18
5.12	Time Format	5-19
5.13	Print Format	5-20
5.14	Audible Signals	5-21
5.15	Units	5-22
5.16	Date Format	5-22
5.17	Duplicate Print	5-23
5.18	Leaving Change Values	5-23

LIST OF TABLES











Table	Title	Page
2-1	Cycle Availability	2-1
2-2	Item Processing Guidelines For Express Cycle	2-2
3-1	Required Feed Water Quality for Carbon Steel Steam Generators	3-12
4-1	Factory-Set Cycles and Cycle Values	4-7
4-2	Liquid Cycle Parameters	4-30
5-1	Cycle Availability	5-1
5-2	Factory-Set Cycles and Cycle Values	5-2
5-3	Change Machine Setup	5-10

SUMMARY OF SAFETY PRECAUTIONS

1

Following is a list of the *Safety Precautions* which must be observed when operating this equipment. WARNINGS indicate the potential for danger to personnel, and CAUTIONS indicate the potential for damage to equipment. These precautions are repeated (in whole or in part), where applicable, throughout the manual. This is a listing of all *Safety Precautions* appearing in the manual. Carefully read them before proceeding to use or service the unit.



WARNING - BURN HAZARD:

-  **When sterilizing liquids**, to prevent personal injury or property damage resulting from bursting bottles and hot fluid, you must observe the following procedures:
 - Use Liquid cycle only; no other cycle is safe for processing liquids.
 - Use only vented closures; do not use screw caps or rubber stoppers with crimped seals.
 - Use only Type I borosilicate glass bottles; do not use ordinary glass bottles or any container not designed for sterilization.
 - Do not allow hot bottles to be jolted; this can cause hot-bottle explosions. Do not move bottles if any boiling or bubbling is present.
-  **It is inappropriate for a healthcare facility to sterilize liquids for direct patient contact.**
-  **Sterilizer, rack/shelves, and loading car will be hot after cycle is run.** Always wear protective gloves and apron when removing a processed load. Protective gloves and apron must be worn when reloading sterilizer following the previous operation.
-  **Before daily flushing of the generator, generator must be at zero psig** and cooled to room temperature.
-  **Do not** attempt to open the sterilizer door if a **WATER IN CHAMBER ALARM** condition exists. Call a qualified service technician before attempting to use sterilizer further.
-  **Sterilizer operator may be severely burned by scalding water if the water level control malfunctions.** The steam generator level control may malfunction if the supply water exceeds 26,000 ohms/cm (38.5 conductivity min.). Do not connect to treated water (e.g., distilled, reverse osmosis, deionized) unless water resistivity is determined to be acceptable. If water exceeds 26,000 ohms/cm, contact STERIS Engineering Service for information concerning modifications required to the generator control system.
-  **After manual exhaust, steam may remain inside the chamber.** Always wear protective gloves, apron and a face shield when following emergency procedure to unload sterilizer. Stay as far back from the chamber opening as possible when opening the door.
-  **Allow sterilizer to cool to room temperature** before performing any cleaning or maintenance procedures.
-  **Failure to shut off the steam supply** when cleaning or replacing strainers can result in serious injury. Jacket pressure must be 0 psig before beginning work on the steam trap.
-  **Proper testing of the safety valve requires the valve to be operated under pressure.** Exhaust from the safety valve is hot and can cause burns. Proper safety attire (gloves, eye protection, insulated overall) as designated by OSHA, is required. Testing is to be performed by qualified service personnel only.
-  **Steam may be released from the chamber when door is opened.** Step back from the sterilizer each time the door is opened to minimize contact with steam vapor.

WARNING – ELECTRIC SHOCK AND BURN HAZARD:

-  **Disconnect all utilities to sterilizer before servicing.** Do not service the sterilizer unless all utilities have been properly locked out. Always follow OSHA Lockout-Tagout and electrical safety-related work practice standards. (See CFR 1910.147 and .331 through .335.)

WARNING – PERSONAL INJURY HAZARD:

-  **Avoid personal injury from bursting bottles.** Liquid sterilization cycle must only be used for liquids in borosilicate (Pyrex) flasks with vented closures.
-  **Door must be locked and the key retained prior to entering chamber for servicing.** Always follow appropriate Lockout-Tagout and electrical safety-related work practice standards. Emergency stop switch can be depressed and key retained on sliding door units.



WARNING - EXPLOSION HAZARD:

-  **This sterilizer** is not designed to process flammable compounds.





WARNING - SLIPPING HAZARD:

-  **To prevent falls keep floors dry** by immediately wiping up any spilled liquids or condensation in sterilizer loading or unloading area.

















WARNING – PERSONAL INJURY AND/OR EQUIPMENT DAMAGE HAZARD:

-  **Regularly scheduled preventive maintenance is required** for safe and reliable operation of this equipment. Contact your STERIS service representative to schedule preventive maintenance.
-  **When closing the chamber door,** keep hands and arms out of the door opening and ensure opening is clear of obstructions.
-  **Repairs and adjustments to this equipment** must be made only by fully qualified service personnel. Maintenance performed by inexperienced, unqualified persons or installation of unauthorized parts could cause personal injury or result in costly equipment damage.

WARNING - STERILITY ASSURANCE HAZARD:

-  **Load sterility may be compromised if the biological indicator or air leak test indicates a potential problem.** If these indicators show a potential problem, refer the situation to a qualified service technician before using the sterilizer further.
-  **According to AAMI standards, a measured leak rate greater than 1.0 mm Hg/minute indicates a problem with the sterilizer.** Refer the situation to a qualified service technician before using the sterilizer further.
-  **The Express cycle is only intended for use with a single instrument in a single wrapped instrument tray.**
-  **The Express cycle is not intended for processing porous items (except the tray wrapper).**
-  **The Flash cycle is not intended for processing porous items.**

CAUTION - POSSIBLE EQUIPMENT DAMAGE:

-  Gasket must be fully retracted prior to operating sterilizer door.
-  Failure to flush generator daily could result in malfunction of the generator. Warranty on the generator will be voided unless flushed daily.
-  Before flushing generator, ensure generator drain valve is fully open to prevent generator heaters from turning on during flush phase.
-  If zero dry time is selected, sterilizer automatically initiates a vapor removal phase in place of drying. This phase can still draw a vacuum to 5.0 inHg. Consult device manufacturer's recommendations to ensure devices being processed can withstand this depth of vacuum.
-  Lifting the chamber float switch when cleaning the chamber may cause the sterilizer control to initiate a "Chamber Flooded" alarm. If this alarm condition occurs, the operator must turn the control power OFF then ON to clear the alarm. The control power switch is located in the mechanical area at the side of the sterilizer. Placing the sterilizer in standby does not clear this alarm.
-  Never use a wire brush, abrasives, or steel wool on door and chamber assembly. Do not use cleaners containing chloride on stainless-steel surfaces. Chloride-based cleaners will deteriorate stainless steel, eventually leading to failure of the vessel.
-  Do not use cleaners containing chlorides on loading cars. Chloride-based cleaners will deteriorate the loading car metal.
-  Sterilization of chloride-containing solutions (e.g., saline) can cause chamber corrosion and is not recommended by the manufacturer. If, however, chloride-containing solutions must be processed, clean the chamber after each use.
-  Allow thermostatic traps to cool down to room temperature before removing cover. Since there is nothing to limit expansion, the bellows may rupture or fatigue if trap is opened while hot.
-  Actuation at less than 75% of rated pressure can allow debris to contaminate the seat and cause the safety valve to leak. A leaking safety valve must be replaced.
-  Insufficient service clearance will make repairs more difficult and time-consuming.
-  Piping sized too small may cause water hammer, resulting in damage to the sterilizer.
-  After installation, it is mandatory to brace piping at the drain funnel so that it will not move vertically.
-  Make sure door opening is clear of any obstruction before closing the door(s).
-  Do not attempt to open sterilizer door during manual operation unless chamber is at 0 psig.
-  During manual operation, gasket must be fully retracted prior to operating sterilizer door.
-  Immediately wipe up saline solution spills on loading car, to prevent damage to stainless steel.

2.1 General

⚠ WARNING – BURN HAZARD: It is inappropriate for a health care facility to sterilize liquids for direct patient contact.

The information in this section is intended as a general guide to steam sterilization techniques. Also recommended is reference to the standards of the Association for the Advancement of Medical Instrumentation (AAMI ST-46, *Steam Sterilization and Sterility Assurance, 3rd Edition*).

- Prior to sterilization, all materials and articles must be thoroughly cleaned.
- After sterilization, goods should be stored in conditions that will not compromise the barrier quality of their wrapping materials.
- Always carefully segregate items which have been sterilized using conventional cycles from those sterilized using Flash or Express cycles.

IMPORTANT: The sterilization cycles listed in **Table 2-1** have been validated using techniques documented in AAMI ST-8 and AAMI ST-37. If different cycle parameters (sterilize time and dry time only) other than those in **Table 2-1** are required, it is the responsibility of the health care facility to validate the cycle. Reference AAMI guidelines/standards for a guide to validating sterilization cycles and to ensure that proper sterility assurance level (SAL) as well as moisture retention acceptance criteria are met.

NOTE: Contact your customer service representative for information on a wide range of education/training programs designed to meet the educational needs of health care industries.

The **Express cycle** is an **abbreviated prevacuum cycle** that is intended for use *only* on prevacuum sterilizers, and is not provided on gravity sterilizers.

Table 2-1. Cycle Availability

Cycle Type	Load	Sterilize Temperature	Sterilize Time	Dry Time	Prevac		Gravity	
					Default	Optional	Default	Optional
Gravity*	Full Load Fabric Packs	270°F	25 min	15 min		X		X
Gravity*	Full Load Fabric Packs	250°F	30 min	15 min		X	X	
Gravity*	Full Load Instrument Trays	270°F	15 min	30 min		X	X	
Gravity*	Full Load Instrument Trays	250°F	30 min	30 min		X		X
Liquid*	Three 1000ml Bottles	250°F	45 min	N/A		X		X
Prevac*	Single Fabric Pack	270°F	4 min	5 min		X	N/A	N/A
Prevac*	Full Load Instrument Trays	270°F	4 min	20 min	X		N/A	N/A
Prevac*	Full Load Instrument Trays	275°F	3 min	16 min	X		N/A	N/A
Flash**	Unwrapped, Non-porous Instrument Tray	270°F	3 min	1 min	X		X	
Express**	Single-wrapped Instrument Tray	270°F	4 min	3 min	X		N/A	N/A
Flash	Unwrapped, Non-porous Instrument Tray	270°F	10 min	1 min	X		X	
DART*	Bowie-Dick Test Pack	270°F	3½ min	1 min	X		N/A	N/A
Leak* Test	None	N/A	N/A	N/A	X		N/A	N/A

*Cycles qualified to AAMI ST-8

**Cycles qualified to AAMI ST-37

2.2 Special Information Regarding the Express Cycle

Appropriate parameters for sterilization are preset by STERIS. It is designed to permit sterilization using a single instrument in a **single** wrapper (non-woven or textile, but not a peel pouch) on the instrument tray.

Rationale: The single wrapper serves to confine and contain the sterilized item from environmental contaminants that may be encountered enroute from the sterilizer to the point of use. A single wrapped item sterilized with the Express cycle does not have a shelf life.

The Express cycle is useful in providing quick turnaround of an instrument using the wrapped technique for transport from the sterilizer to the point of use.

Instrument trays processed using the Express cycle are intended for immediate use.

WARNING – STERILITY ASSURANCE HAZARD:
The Express cycle is only intended for use with a single instrument in a single wrapped instrument tray.

2.2.1 Preparing Instruments for Express Cycle Sterilization

Decontaminate and then prepare a surgical instrument (open and/or disassembled), and place in a perforated or mesh bottom instrument tray. Only non-porous items (except for the wrapper) should be processed using this cycle.

Items with lumens (e.g., needles for injection and diagnostics or metal suction cannulae) are considered porous items, and must not be processed using this cycle.

The Express cycle has fewer prevacuum pulses so air removal and subsequent steam contact within lumens may be difficult to achieve.

WARNING – STERILITY ASSURANCE HAZARD:
The Express cycle is not intended for processing porous items (except the tray wrapper).

Table 2-2. Item Processing Guidelines for Express Cycle

Examples of non-porous items that can be processed using the Express cycle:

- Forceps,
- Needle Holders,
- Scissors and other routine metal instruments.

Examples of porous items that CANNOT be processed using the Express cycle:

- Towels,
- Rubber or Plastic Items,
- Items with Lumens,
- Items with sliding parts that prevent sterilant contact with surfaces.

2.2.2 Unloading

Use instrument processed in an Express cycle immediately. Do not store for later use.

When opening and unloading the sterilizer at the conclusion of the Express cycle always use aseptic techniques. Sterile towels and sterile gloves are used to remove the tray from the sterilizer. The still-wrapped tray is transported to the point of use, being careful not to contact any unsterile surfaces. The tray is placed on a previously draped sterile surface field and the wrapper opened by the circulating nurse. The draping material used must be impervious to liquids and able to withstand contact with hot surfaces.

To shorten the sterilization process, drying time has been reduced in the Express cycle. Thus, the single wrapper will appear dry at the conclusion of the cycle, but the content of the package will, in all probability, still be wet with condensation formed during sterilization. Water will penetrate the wrapper, especially on the under side of the tray because of gravity. The wrapper only serves the function of protecting the tray and its content from particulate matter encountered on the way from the sterilizer to the point of use.

Any moisture present can strike through the wrapper, so procedures should be developed to avoid contamination by contact with unsterile surfaces. For example:

- Wear sterile gloves and use sterile towels as “pot holders” when removing the goods from the sterilizer.
- Never place the wrapped tray on an unsterile surface.

2.3 Special Information Regarding The Flash Cycle

The **Flash Cycle** is an **abbreviated gravity cycle** and is provided on both the Amsco® Century® prevacuum and gravity configurations. The Flash cycle has been designed to sterilize an unwrapped item at sterilization parameters preset by STERIS. There is **no storage or shelf life** of flash sterilized items.

Rationale: The Flash Cycle is intended for sterilizing an unwrapped item intended for immediate use (e.g. a dropped instrument). In any method of sterilization, it is important to adhere to good processing practices. This is particularly important in **flash sterilization**.

Preparing Instruments For Flash Cycle Sterilization

As prescribed in AAMI ST-37, prior to flash sterilization of a dropped instrument, ensure the item is free of soil by the appropriate decontamination procedure. The flash sterilized item then must be transferred immediately, using aseptic technique, from the sterilizer to the actual point of use, usually the sterile field in an ongoing sterile procedure.

Use items processed in a Flash Cycle immediately. Do not store the processed items for later use.

 **WARNING – STERILITY ASSURANCE HAZARD:**
The Flash cycle is not intended for processing porous items.

2.4 Control Measures For Verifying Sterilization Process

2.4.1 Biological Monitors

As part of the operator's verification of the sterilization process, biological indicators may be used to demonstrate that sterilization conditions have been met.

NOTE: Contact STERIS for information on specific biological indicators recommended for use with this sterilizer.

A live spore test utilizing *G. stearothermophilus* is the most reliable form of biological monitoring. This type of product utilizes controlled populations of a controlled resistance, so that survival time and kill time can be demonstrated.

To verify the process, insert the biological indicator in a test pack and place pack on the bottom shelf. Run test pack through a typical cycle. On completion, forward test pack and monitor to appropriate personnel for evaluation. Refer to AAMI guidelines to conduct routine biological monitoring.

2.4.2 Testing for Prevacuum Efficiency

Run a Dart® (Bowie-Dick test) cycle daily before processing any loads. The first prevacuum cycle of each day should be used to test the adequacy of air removal from the chamber and load, so that steam can penetrate the load. It is not a test for adequate exposure to heat in terms of time-at-temperature.

Tests such as the Bowie-Dick or the Dart® (Daily Air Removal Test)* are designed to document the removal of residual air from a sample challenge load.

In the case of these tests, following exposure in a prevacuum sterilizing cycle, the pack is opened, the indicator examined and conclusions are drawn as to the pattern of residual air, if any, that remained in the pack during the sterilizing cycle. Any indication of a malfunction must be reported to the supervisor. Sterilizer should not be used during this time.



WARNING – STERILITY ASSURANCE HAZARD: Load sterility may be compromised if the biological indicator or air leak test indicates a potential problem. If these indicators show a potential problem, refer the situation to a qualified service technician before using the sterilizer further.

* Available from STERIS.

2.5 Dart (Bowie-Dick) Test

Conduct a residual air test (e.g., Bowie-Dick test) at the beginning of each day according to the AAMI standard ST-46. STERIS can provide a product called Dart® (Daily Air Removal Test), designed to be as sensitive as the standard AAMI Bowie-Dick test pack in detecting air leaks. Refer to instructions for running Dart test given in Section 4 of this manual. If a Dart is not available, construct Bowie-Dick test package in accordance with instructions given in AAMI standard ST-8.

2.6 Vacuum Leak Test

 **WARNING – STERILITY ASSURANCE HAZARD:** According to AAMI standards, a measured leak rate greater than 1.0 mm Hg/minute indicates a problem with the sterilizer. Refer the situation to a qualified service technician before using the sterilizer further.

Run the Vacuum Leak test cycle daily or weekly. This test measures the integrity of the sealed pressure vessel and associated piping to assure air is not being admitted to the sterilizer during the vacuum draw downs. Refer to appropriate cycle description in Section 4 of this manual.

After running a vacuum leak test, a value or leak rate will be printed on the printer tape. This value will help define a trend over a period of time if the integrity of the system begins to deteriorate (i.e., allowing air to enter the system). By running a vacuum leak test cycle daily or weekly, the operator or maintenance personnel can always monitor the air tightness of the system and make repairs or adjustments when necessary.

NOTE: A leak rate of greater than 1.0 mmHg per minute indicates a problem with the sterilizer that must be addressed.

2.7 Sterilization Process Recommendations

Saturated steam is a well controlled, reliable method for processing items which can withstand the temperatures and pressures associated with steam sterilization. The requirements for achieving reproducible results are well known by many users, but are not always understood by all users.

The condition most likely to result in sterilization problems is a failure to remove all of the air from the items being processed. For example, placing an empty beaker or bowl in an upright position in a gravity displacement sterilizer may result in the object not being sterilized, or may require exceptionally long sterilization times. This problem is because air has almost twice the density as does saturated steam under the same conditions. Thus, the air sits in the bottom of the container, and the steam forms a stable layer over the air. This effect is similar to oil forming a stable layer over water. As long as there is no mechanism for actively mixing the two, the bottom of the container will only see dry heat, which is not an effective sterilization method at the temperatures typically used in steam processes.

There are two traditional methods for enhancing the sterilization of solid bottom containers in gravity displacement cycles. These are:

- Place 1.0 mL of water for each liter of volume in the bottom of each container. The expansion of the water into steam as the product is heated will force most of the air out of the object, thus allowing steam to reach all surfaces and effect sterilization.
- The better, more reliable method is to orient all objects in a manner which would allow water to flow out. When the steam enters the chamber, it will tend to layer over the air. However, the object is now oriented so the air can flow out. As the air flows out of the container, it will be replaced by the steam. The steam can now reach all surfaces and effect sterilization.

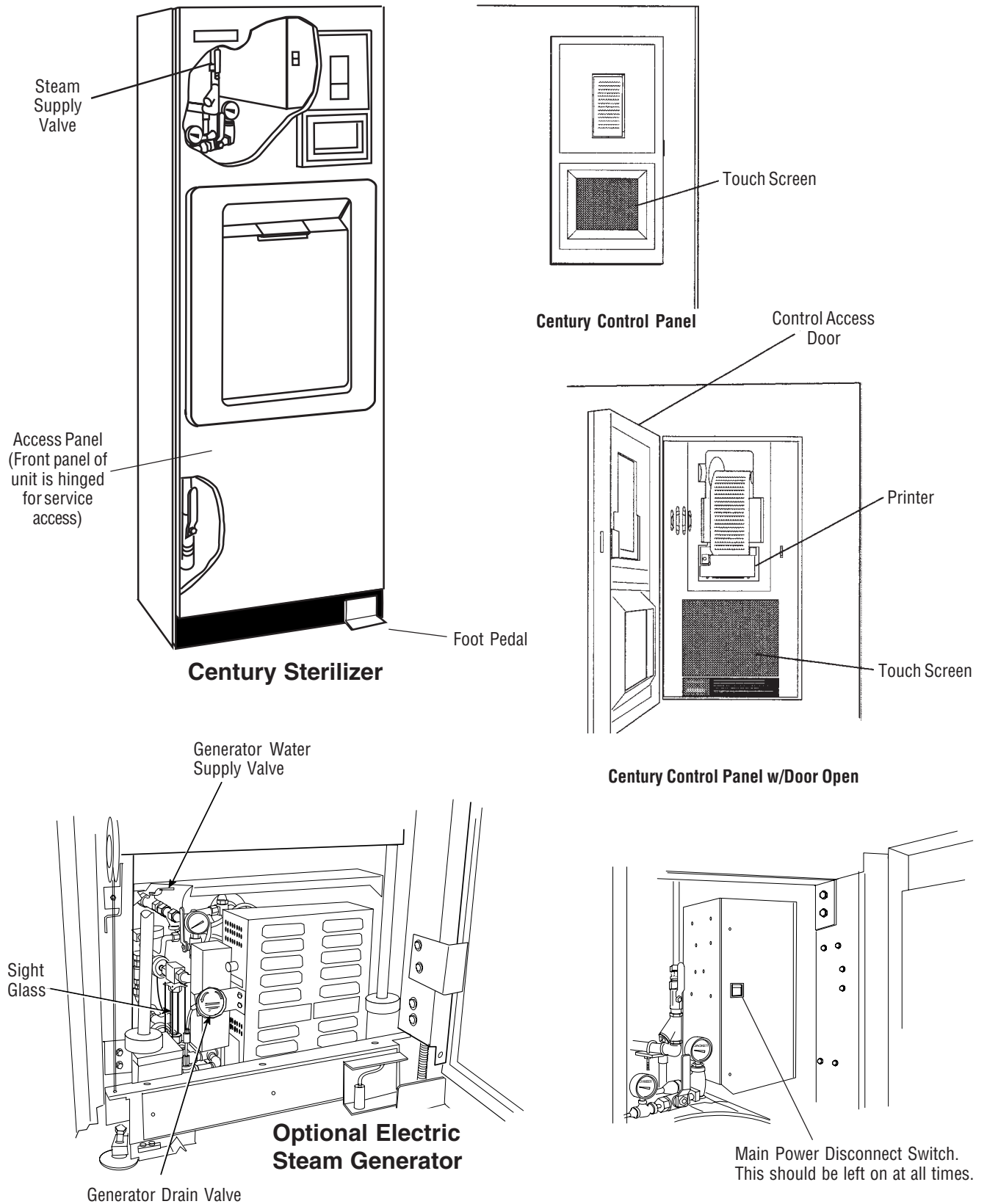
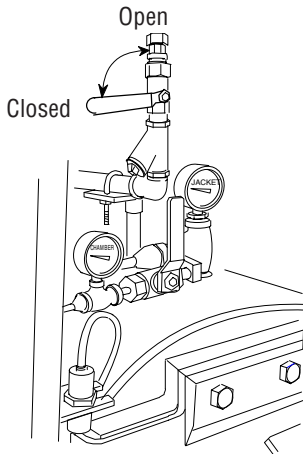

Figure 3-1. Amsco® Century® Sterilizer Components

3.1 General

Use this manual to become familiar with control locations and functions before operating the sterilizer (refer to Fig. 3-1). The controls for this sterilizer are contained within the control touch screen. Control touch pads appear on the screen as needed during each operation. Available controls change as the sterilizer steps through different operations.

3.2 Main Sterilizer and Cycle Controls



Steam Supply Valve

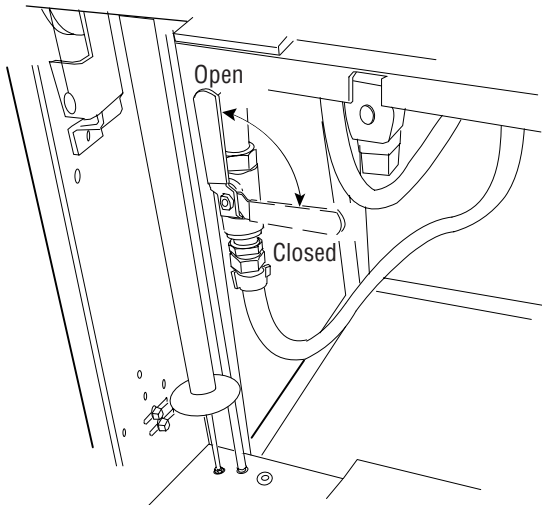

Water Supply Valve

- **Main Power Disconnect Switch** (refer to Fig. 3-1) – Located behind the access door, on the main control box, this switch disconnects power to the control. Under normal operation, this switch is left in the open position at all times.
- **Steam Supply Valve** – This is located behind the front access door, above the chamber door. Refer to Figure 3-2. Ensure this is in the open position before trying to operate the sterilizer.
- **Water Supply Valve** – This is located behind the front access door, below the chamber door. Refer to Figure 3-2. Ensure this is in the open position before trying to operate the sterilizer.
- **Steam Generator Control** – The optional integral electric steam generator (if present) is located in the space below the sterilizer chamber. The generator is automatically turned on by the sterilizer's control when the sterilizer is turned on. Refer to the instructions later in this section before operating a sterilizer equipped with an integral steam generator.

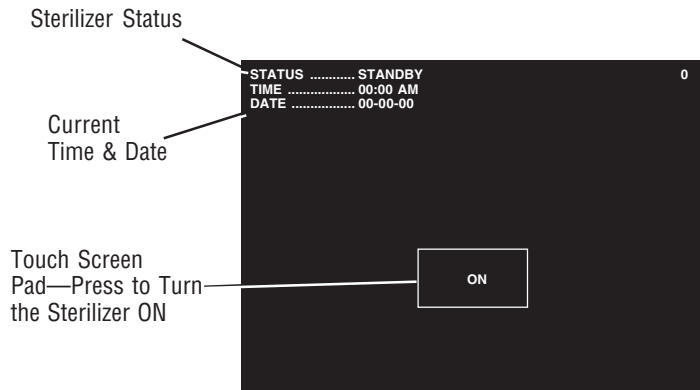

Standby Screen

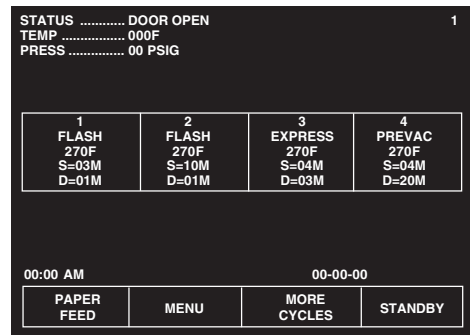

ON Screen

Figure 3-2. Main Sterilizer and Cycle Controls

- » **Generator Water Supply Valve** (refer to Fig. 3-1) – This valve should always be open. Ensure it is open before attempting to operate the sterilizer.
- » **Generator Drain Valve** (refer to Fig. 3-1) – This should be opened once a day, while generator is at room temperature, to flush the generator of residual solids (present in most water) that may have accumulated in the generator's boiler. After the boiler has been flushed ensure the drain valve is then closed. Refer to instructions later in this section.
- **Sterilizer Control Touch Pad** – This is visible on the control touch screen whenever the sterilizer is in Standby mode. Refer to Figure 3-2.

NOTE: Screen touch pads respond to very slight pressure, and only need to be pressed lightly.

The sterilizer enters operating mode when the ON touch pad is pressed. This touch pad switches the sterilizer control between Standby and Ready conditions (Standby mode is usually used at night when the sterilizer is not being operated—steam is turned off and machine cools, saving energy).

3.3 Control Displays

A screen reference number appears in the upper right corner of each display. Numbers are used for reference only, and do not relate to the operating sequence of the screen.

Control displays can be divided into two categories, those occurring when the sterilizer is "out-of-cycle" and those occurring when the sterilizer is "in-cycle".

Typical out-of-cycle and in-cycle displays are shown in Figure 3-3.

- Out-of-cycle displays are used to start cycles, or set up and adjust sterilizer operation. With the exception of the cycle starting displays, most out-of-cycle displays will only be used occasionally. Detailed instructions for adjusting the sterilizer operating parameters are in Section 5 of this manual.
- Generally, when the sterilizer is in-cycle, displays appear automatically and, unless an abnormal conditions occurs, require no special attention or instructions. In-cycle displays tell the operator at what temperature and pressure the sterilizer chamber is operating, show the current cycle phase and indicate when the processing cycle is complete. For more details about operating cycles, refer to Section 4 of this manual.

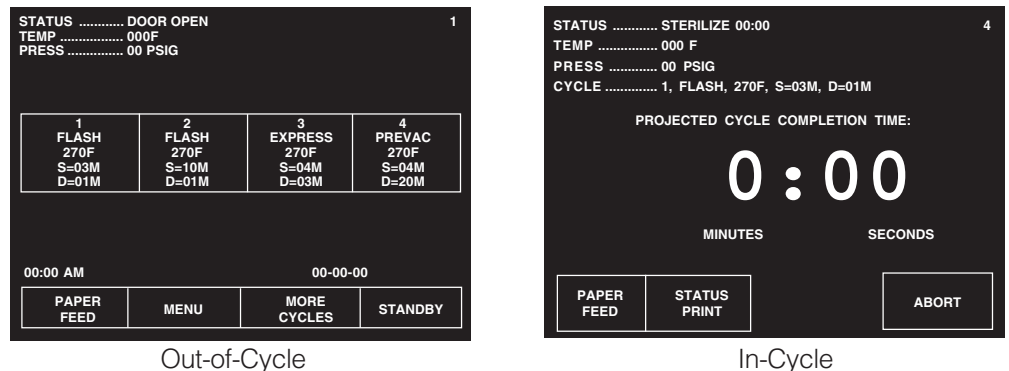

Figure 3-3. Typical In and Out-Of-Cycle Display

3.4 Alarm Displays

Alarm displays tell operators and technicians when the sterilizer is experiencing an abnormal condition. Alarm conditions can be caused by failure of utility supplies or sterilizer components. Section 5 of **ROUTINE MAINTENANCE MANUAL** (P129367-410), details the steps an operator can take to solve most alarm conditions. Typical alarm displays are shown in Figure 3-4.

When an alarm occurs during cycle operation, a display appears on the screen, accompanied by an audible tone. This display indicates the problem as determined by control sensors, and lists a brief troubleshooting list. The operator should follow the instructions on the screen, if possible. If these instructions fail to clear the alarm, consult your departmental supervisor or a trained service technician before using the sterilizer further.

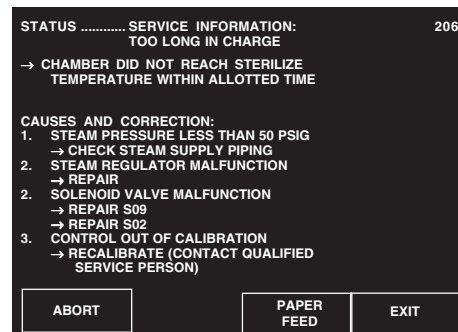
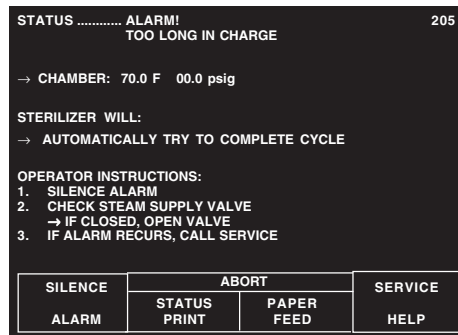

Figure 3-4. Typical Alarm Displays

3.5 Operating End Control Panel

A sterilizer equipped with two doors, will also be equipped with two control panels. The control panel at the loading door of the sterilizer is referred to as the "operating end control," the control panel located at the unloading door is referred to as the "non-operating end control."

A single-door sterilizer is equipped with an "operating end control," only.

NOTE: Except for the presence of the printer (which is only present at the operating end of the unit), control panels at both ends of the unit are similar and each can be used to start or abort the sterilizer.

The operating end control panel (see Fig. 3-5) is used to:

- Select and start cycles.
- Abort cycles.
- Set cycles and cycle values.
- Obtain status printouts (see "Printer" paragraph later in this section).

The operating end control includes a printer for cycle documentation.

Cycle status and control messages are shown on a 30 column x 40 line graphics display. Cycles can be started or aborted using the touch screen pads. Cycles and cycle values can be set using the Change Values procedure (accessible from the sterilizer MENU screen). If changing cycle values becomes necessary, refer to Section 5 of this manual.

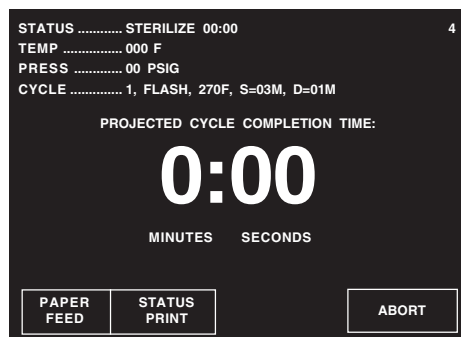

When in-cycle, the display shows a status of the sterilizer, status of the cycle, and large numbers indicate the approximate time remaining in the current cycle.

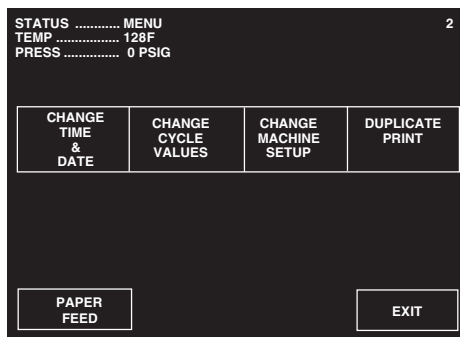

Menu Screen

Typical Menu Screen

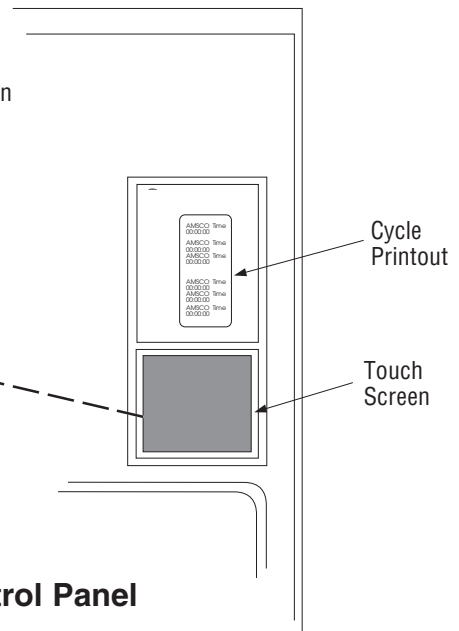

Figure 3-5. Operating End Control Panel

3.6 Cycle Selection Touch Screen Pads

Four cycle selection touch pads are shown on the screen in Figure 3-6. These pads display the basic parameters of the cycle (cycle name, sterilization exposure temperature, sterilization exposure time and dry time), additional cycles may be selected by pressing **MORE CYCLES**. Details on individual cycles are in Section 4.8.

Up to seven additional cycles can be programmed and displayed. It is the responsibility of the healthcare facility to validate the cycle. Reference AAMI for guidelines and standards for a guide to validating sterilization cycles and to ensure that proper sterility assurance level (SAL) as well as moisture retention acceptance criteria are met.

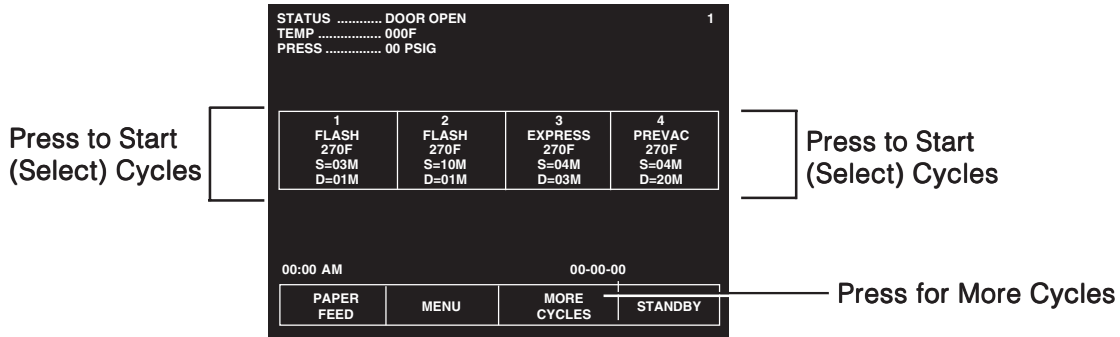

Figure 3-6. Cycle Selection Touch Pads

3.6.1 Values Touch Screen Pads

These touch screen pads are accessed through the MENU screen by pressing **CHANGE CYCLE VALUES**. The values touch pads are used for changing the operating values used in cycles, changing the cycles displayed on the cycle selection menus, and for changing the operating settings of the sterilizer. Instructions for changing sterilizer cycle parameters are in Section 5 of this manual.

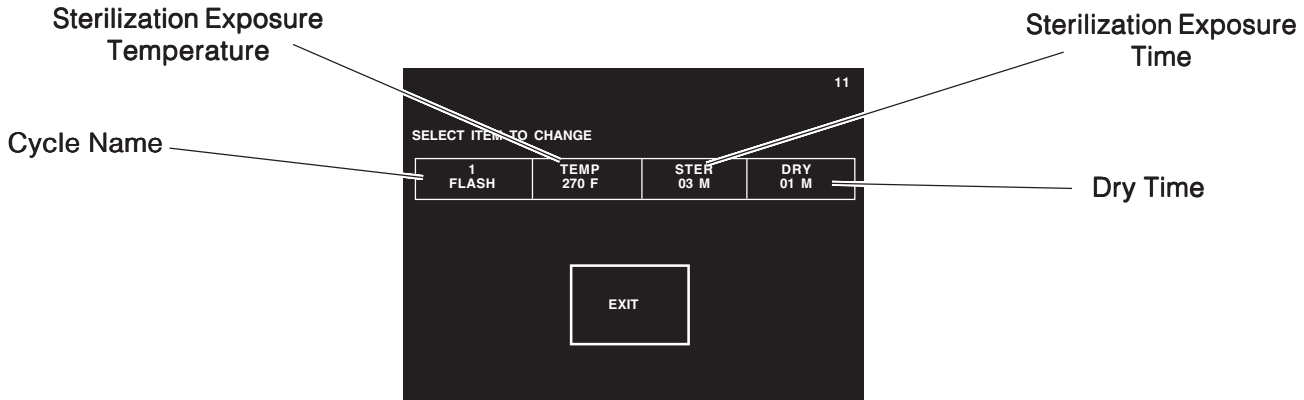

Figure 3-7. Values Touch Screen Pads

3.6.2 Abort Touch Screen Pad

The **ABORT** touch screen pad is used to end a cycle before it finishes normally. A cycle only needs to be aborted if an abnormal condition or a control problem develops during the cycle. Pressing **ABORT** causes the sterilizer chamber to depressurize (if pressurized), or Air Break (if in vacuum), the door seal deactivates, the control prompts the operator to open the door, and the sterilizer returns to its normal out-of-cycle state. If an abnormal condition persists after fully aborting the cycle, contact your supervisor or a qualified service technician before trying to operate the sterilizer further.



Figure 3-8. Cycle AbortTouch Screen Pad

3.7 Printer

Refer to Figure 3-1.

Printer records all cycle data on 2-1/4 inch wide single-ply paper. See **ROUTINE MAINTENANCE MANUAL (P129367-410)** for paper changing procedure. Printer functions controlled by touch screen pads are as follows:

- **Paper Feed** — Press to feed out paper from the roll stored inside the control. Accessible during all phases of operation, including alarm conditions. Press and hold for continuous feed.
- **Duplicate Print** — Press to obtain a complete duplicate printout of the last previously run cycle (when unit is not in cycle). This touch pad is only visible on the screen during Complete and Change Values menu. The Duplicate Print touch screen pad is not visible upon first power-up of the day.
- **Status Print** — Press to obtain a printout of current cycle phase and conditions (when unit is in cycle). This touch pad is only visible during cycle operation.
- **Print Values** — Press to obtain a printout of all currently set cycles and cycle values. Only accessible when the unit is not in cycle. This touch screen pad appears on Change Values menu only.

3.8 Printouts

Refer to Figure 3-9.

The printout reports useful information about each cycle the sterilizer runs. This includes the load number, which is a unique identifying code. Each load number is printed in the following format: a two digit month (e.g., January = 01), a two digit day (e.g., second day of any given month = 02) and a two digit daily cycle count (e.g., third cycle of the day = 03). In our examples the complete load number would then be 010203.

During the cycle, status lines on the printouts show the time the line was printed, chamber temperature and the level of vacuum or pressure in the chamber. Each status line also begins with a letter code. This code indicates during which cycle phase the print line occurred, or what kind of event caused the print line to occur.

Refer below to see other features of the printout.

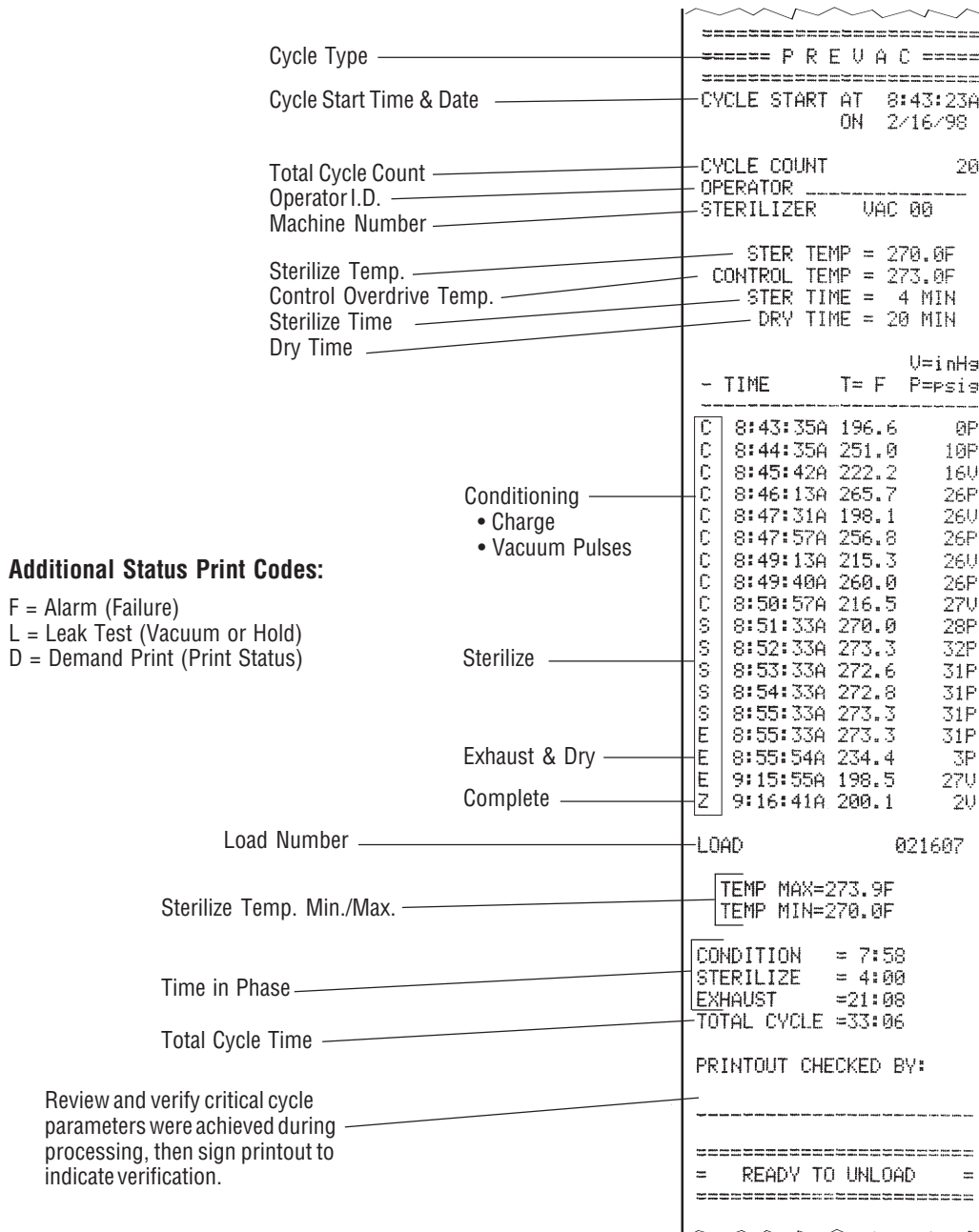

Figure 3-9. Typical Printout

3.9 Power Door Operation

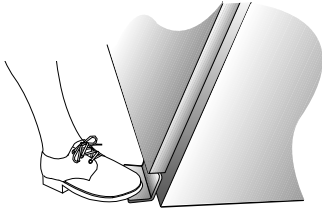

Figure 3-10. Foot Pedal

⚠ WARNING - PERSONAL INJURY HAZARD: When closing the chamber door keep hands and arms out of the door opening and ensure opening is clear of any obstructions.

The sterilizer door is operated at the foot pedal (refer to Fig. 3-10).

- Pressing the foot pedal while the door is in the closed (up) position causes the door to open (lower).
- Pressing the foot pedal while the door is in the open (lowered) position, causes the door to close (by raising).

NOTE: The foot pedal only provides control of the visible door. For double-door units, the foot pedal cannot be used to control the door at the opposite end of the sterilizer.

Important: Keep the door closed when the unit is not in use.

Operation of Power Door if Motor Fails

If the power door cannot be operated using the foot pedal (such as during a power failure or if the drive mechanism is damaged), it is still possible to operate the door manually.

Using hand pressure, pull up or push down on the handle to operate the door. Increased effort is required on the part of the operator to slide the door. **Do not** try to raise or lower door rapidly as fast operation may damage the door drive mechanism.

NOTE: If the power fails, and pressure remains in the sterilizer chamber, refer to Section 3.10, Emergency Door Opening Procedure.

3.10 Emergency Door Opening Procedure

This procedure should only be used when pressure remains in the sterilizer chamber, and the door cannot be opened normally because the sterilizer has lost either electrical or water utilities. This emergency door opening procedure can be used to retrieve a load in the chamber. This procedure requires pushing on the door cover to retract the door seal into the groove, then pushing the door downward manually.

⚠ WARNING – BURN HAZARD: Do not attempt to open sterilizer door if a water in chamber alarm condition exists.

Procedure:

1. Swing open the access panel of the sterilizer. Open the emergency exhaust hand valve until chamber exhausts to 0.0 psig. See Figure 3-11.
2. Using the door release tool provided, press on the upper left hand and right hand corners of the chamber door (see Fig. 3-11). The door should give inward slightly, indicating that the seal has been pushed into the groove. The door must “bottom out” against the metal end-frame of the sterilizer chamber.
3. Close the access panel of the sterilizer.
4. Press down on the door handle to lower the door. The door will slide stiffly, so be prepared to press down hard.
5. Once the door is open, do not use the sterilizer until the unit has been examined by a qualified service technician. Further use without attention may damage the sterilizer.
6. Close the emergency exhaust valve.

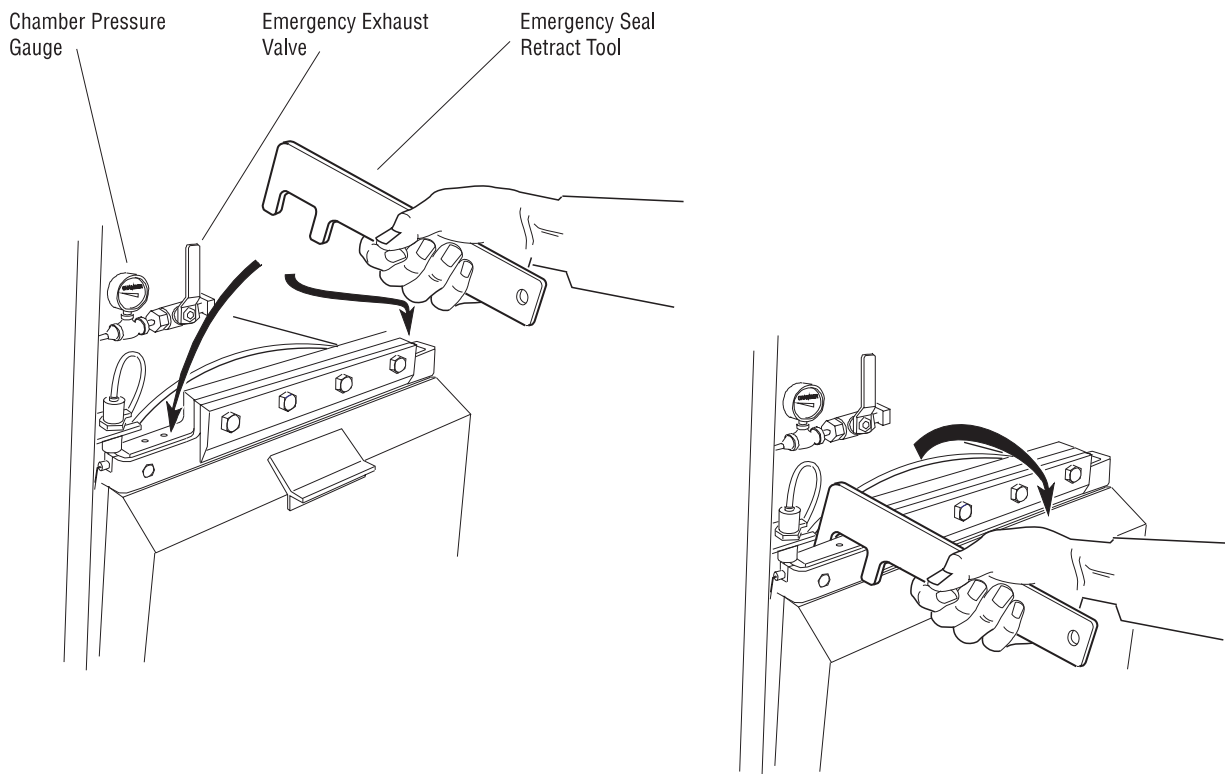

Figure 3-11. Emergency Door Opening Procedure

3.11 Optional Electric Steam Generator

CAUTION – POSSIBLE EQUIPMENT DAMAGE: Failure to flush generator on a daily basis could result in generator malfunction.

Pressing STOP TIMER stops flush phase and resets timer to three minutes.

Pressing CANCEL bypasses flush phase and advances display to screen #1. Do not press CANCEL unless generator has already been flushed that day.

WARNING – BURN HAZARD: Before daily flushing of the generator, generator must be at zero psig and cooled to room temperature.

CAUTION – POSSIBLE EQUIPMENT DAMAGE: Before flushing generator, ensure generator drain valve is fully open.

If a building steam source is not available, the sterilizer may be equipped with an electric steam generator. The generator automatically converts water to steam using electric heat. The steam created is then used to power the sterilizer.

Steam generators are highly susceptible to mineral scaling if the supplied water has any level of hardness. Refer to **Table 3-1** for water quality requirements.

IMPORTANT: Regardless of the hardness level of supplied water, the generator must be flushed every day before use to prevent mineral scaling or carryover of debris into the chamber.

ATTENTION: *Warranty on this steam generator will be voided unless daily flushing procedures are performed.*

Daily Generator Start Up Procedure

1. Press the **ON** button on the sterilizer touch screen (screen #0). Display advances to screen #72. Instructions on how to flush the generator are listed on screen #72.

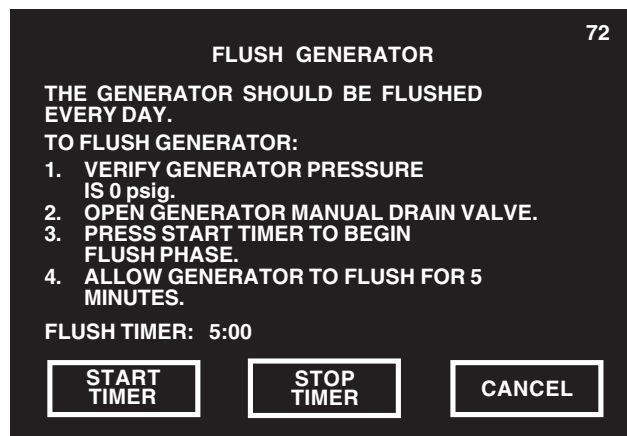

2. Check generator pressure gauge (see Fig. 3-12). Generator must be at 0.0 psig and room temperature before flushing.

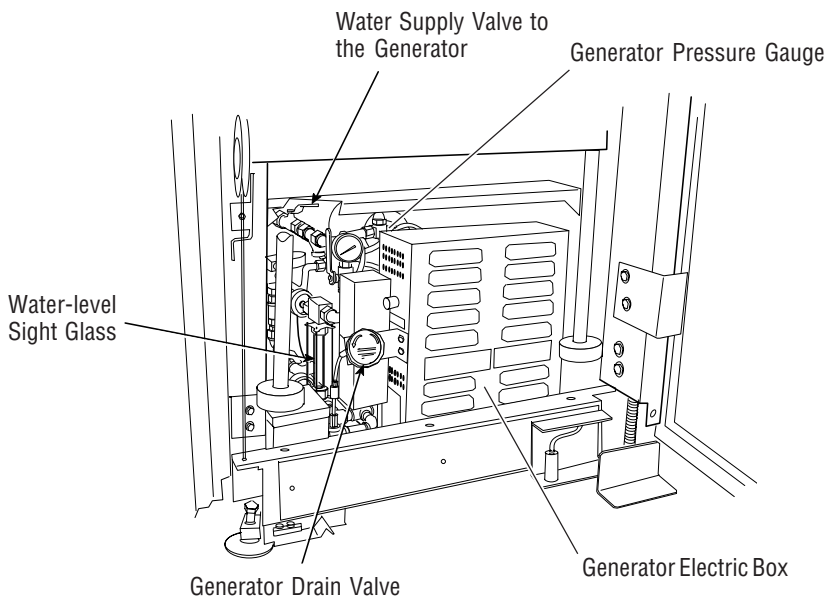
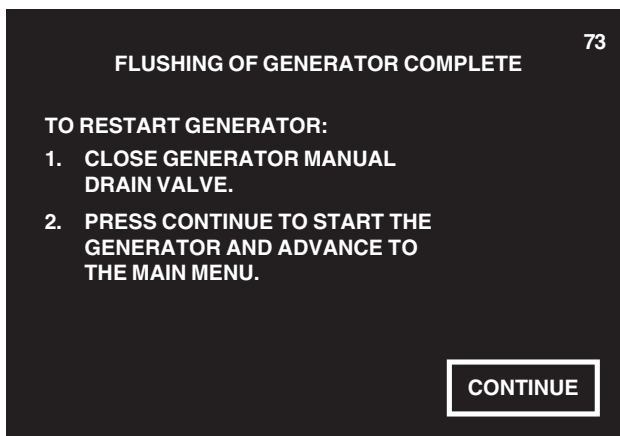

Figure 3-12. Optional Steam Generator

NOTE: If generator is not at 0.0 psi, the Flush can be bypassed by pressing CANCEL, however the flush should not be bypassed on a continuous basis or else damage to the generator may occur. Failure to flush the generator on a daily basis will void the generator warranty.

To ensure generator is at 0.0 psig the sterilizer can be shut off at end of the day and by next morning the unit will be able to be flushed. Approximately seven hours are required for generator to cool down to less than 140°F.

3. Open drain valve on the side of the generator electric box (see Fig. 3-12).
4. Verify that the water supply valve to the sterilizer is open.
5. Ensure the water supply valve to the generator is open (see Fig. 3-12).
6. Press **START TIMER** on screen #72. Water automatically flushes through the generator and out the drain for 3.0 minutes. Flush timer on screen #72 counts down time remaining in the flush phase.
7. After 5.0 minutes, alarm buzzer sounds and display advances to screen #73. Instructions on how to restart the generator are listed on screen #73.



WARNING – BURN HAZARD: Sterilizer operator may be severely burned by scalding water if the water level control malfunctions. The steam generator level control may malfunction if the supply water exceeds 26,00 ohms/cm (38.5 micromhos conductivity min.). Do not connect to treated water (e.g., distilled, reverse osmosis, deionized) unless water resistivity is determined to be acceptable. If water exceeds 26,000 ohms/cm, contact STERIS for information concerning modifications required to the generator control system.

8. Close the generator drain valve.
9. Press **CONTINUE** on screen #73. Generator automatically fills to the proper level and starts to heat. Display screen advances to the Main Menu screen (#1). Allow ten minutes warm-up time once generator starts to fill.
10. Close front cabinet panel.

NOTE: The generator must be flushed every day before use.

Condition	Nominal Conditions	Maximum Conditions
Temperature	as supplied	140° F (60° C)
Total Hardness as CaCO ₃ *	0-17 mg/L	130 mg/L
Total Dissolved Solids	50-150 mg/L	250 mg/L
Total Alkalinity as CaCO ₃	50-100 mg/L	180 mg/L
pH	6.8-7.5	6.5-8.5
Total Silica	0.1-1.0 mg/L	2.5 mg/L
Resistivity - ohms/cm	2000-6000	26000

*17.1 mg/L = 1 grain hardness

4.1 Before Operating the Sterilizer

⚠ WARNING – BURN HAZARD: Sterilizer, rack/shelves, and loading car will be hot after cycle is run. Always wear protective gloves and apron when removing a processed load. Protective gloves and apron must be worn when reloading sterilizer following the previous operation.

⚠ WARNING – SLIPPING HAZARD: To prevent falls keep floors dry by immediately wiping up any spilled liquids or condensation in sterilizer loading or unloading area.

Operate sterilizer by referring to the appropriate cycle description in this section. The steps described on the next three pages are general instructions that apply to all cycle operations.

1. Press **ON** touch screen pad on the sterilizer control display.
 - The printer records the time and date that the power is turned ON.
2. Open chamber door
 - a. Check that drain strainer is clean and in place and that chamber interior is clean. See **ROUTINE MAINTENANCE MANUAL (P129367-410)** if cleaning is necessary.
 - b. Close chamber door.
3. Open access door on the operating end of the sterilizer — refer to Figure 4-1. Turn on steam (Fig. 4-1a) and water (Fig. 4-1b) supplies. Close access door.
 - Steam enters jacket and begins to warm chamber.
4. Open control access door.

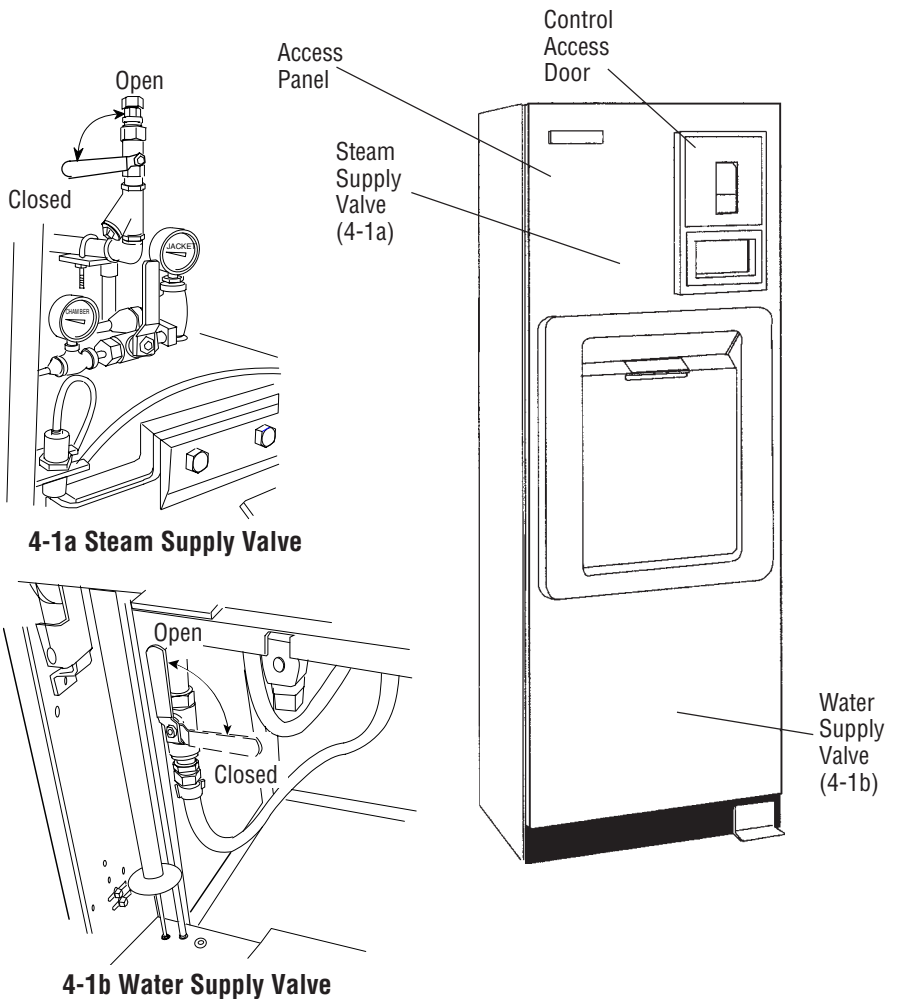

Figure 4-1. Steam Valves

- a. Check printer paper roll.
 - A colored warning stripe is visible when roll is near its end.
- b. See “Changing Paper Roll” in **ROUTINE MAINTENANCE MANUAL (P129367-410)** if a new paper roll is needed.

NOTE: If sterilizer is equipped with an integral electric steam generator (Fig. 3-12), note the following:

1) Verify that the separate water supply hand valve for the generator is also turned on.

2) Refer to Section 3.11 for automatic flush procedure.

5. If the Century sterilizer is a **prevacuum** configuration:
 - » Run a vacuum leak test at least once each week.
 - » Run a DART (Bowie-Dick) test at least once a day.

Press **MORE CYCLES** to access the Vacuum Leak Test and DART cycle selector touch screen pads. For instructions on running these tests refer to cycle descriptions later in this section. Refer also to Section 2, *Sterilization Techniques*.

6. Once these tests have been run (if necessary), proceed to loading the sterilizer and running cycles.

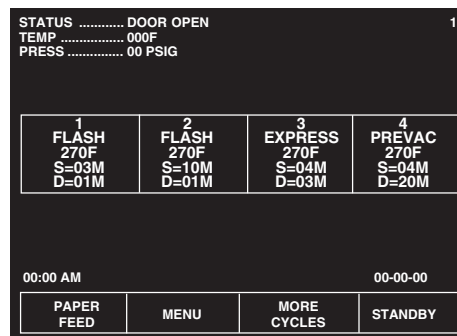

4.2 Preparing Loads for Sterilization Cycles

Before sterilization, all materials must be thoroughly cleaned.

The Amsco® Century® sterilizer chamber holds commonly used wrapped or unwrapped instruments and equipment.

1. Wrappers may be made of 100% cotton (or equivalent), 140 thread count, two-ply fabric, and freshly laundered.
2. Limit the weight of each pack to approximately 3.3 pounds, and density to 11.3 lb/ft³. STERIS recommends following the AAMI-ST8 recommendations in Section 5.5.1.1.
3. Limit the weight of wrapped instrument sets to 17 pounds in order to assist in minimizing moisture retention. STERIS recommends following the AAMI-ST8 recommendations in Section 5.5.3.1.
4. Use two double-thickness 140-thread count muslin (or equivalent) wrappers for surgical supplies. This provides protection after sterilization.

4.3 Guidelines for Placement of Various Loads

 **WARNING – BURN HAZARD:** Sterilizer and shelves will be hot after cycle is run. Protective gloves and apron must be worn when reloading sterilizer following the previous operation.

 **WARNING – PERSONAL INJURY HAZARD:** When closing the chamber door, keep hands and arms out of the door opening and verify opening is clear of any obstructions.

Refer to AAMI ST-46 for load placement guidelines

1. Open the sterilizer chamber door.

NOTE: If a cycle has been run, sterilizer and shelves may be hot. Wear sterile gloves and use sterile towels as "pot holders" when carefully placing the load/tray(s) on the chamber shelves.

2. Place all packs on edge, and arrange load in chamber to allow for maximum exposure, so that there is minimal resistance for steam passage through the load.
3. Place utensils on their edges so that they will be sterilized and properly dried.
4. Place instrument sets in trays that have a perforated bottom (or equivalent). Place flat for sterilization.
5. In mixed loads of fabrics and hard goods, place the hard goods on lower shelf. This prevents wetting of muslin packs from condensate dripping from a hard goods load.
6. **DO NOT OVERLOAD STERILIZER.** Allow for steam penetration between packs. Avoid contact of load components with the wall of the chamber.
7. After placing load in chamber, close the chamber door. The sterilizer is now ready to run a cycle. Proceed to appropriate cycle description in this section.
8. Materials capable of holding water, such as solid-bottomed pans, basins and trays, should be positioned so that they are oriented in the same direction and so that condensate can be eliminated.

4.4 Unloading the Sterilizer

WARNING – BURN HAZARD: Steam may be released from the chamber when door is opened. Step back from the sterilizer each time the door is opened to minimize contact with steam vapor.

WARNING – BURN HAZARD: Sterilizer and shelves will be hot after cycle is run. Always wear protective gloves and apron when removing a processed load. (See Section 1 for additional warnings.)

At the end of a cycle, when end-of-cycle tone sounds and display shows:

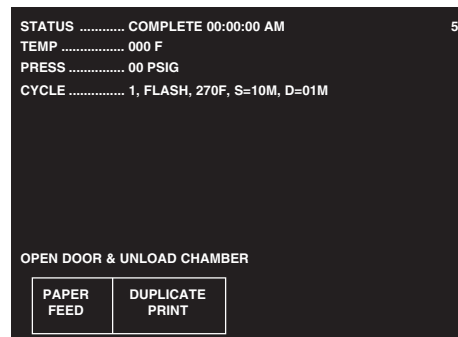

... open the chamber door.

NOTE: Wear sterile gloves and use sterile towels as “pot holders” when carefully removing load/tray(s) from the sterilizer shelves. Never place a sterilized tray on an unsterile or cold surface.

1. Remove the load from chamber shelf (shelves). Avoid unnecessary handling.
2. Visually check outside wrapper for dryness. If there are water droplets or visible moisture on the exterior of the package, or on the tape used to secure it, the pack or instrument tray is considered **unacceptable**.
3. To prevent condensation, transfer the load to a surface which is well-padded with fabric. **Do not place load on a cold surface.** Ensure no air conditioning or cold air vents are in close proximity.
4. Remove packs or instrument trays from the padded surface when they have reached ambient (room) temperature. Depending on the items and environment of the area, this may take a minimum of one hour.

IMPORTANT: After removing load(s) from the chamber, close the chamber door and keep the chamber door closed to minimize utility consumption.

4.5 Loading Car Instructions: Loading

⚠ WARNING – BURN HAZARD: Steam may be released from the chamber when door is opened. Step back from the sterilizer each time the door is opened to minimize contact with steam vapor.

⚠ WARNING – BURN HAZARD: Sterilizer and shelves will be hot after cycle is run. Always wear protective gloves and apron when removing a processed load. (See Section 1 for additional warnings.)

NOTE: The loading car and transfer carriage are for use with the 20-inch Century Sterilizer, only.

1. Open sterilizer door.
2. Verify that loading car is securely fastened to the transfer carriage.
3. Align the front end of the transfer carriage with the end of the sterilizer. See Figure 4-2.
4. Move carriage forward until latches engage with track inside chamber.
5. Verify that transfer carriage is latched to track inside chamber by pulling transfer carriage backwards (transfer carriage should remain stationary).
6. Once transfer carriage is latched to track inside chamber, release the loading car from the transfer carriage by lifting up the carriage lock.
7. Carefully push the loading car off the transfer carriage and fully into the sterilizer chamber.
8. Disengage transfer carriage latches from track inside chamber by pushing carriage latch knob.
9. Close the chamber door.
10. Back the transfer carriage away from the sterilizer.
11. The sterilizer is now ready to run a cycle. Proceed to appropriate cycle description found in Section 4.8 of this manual.

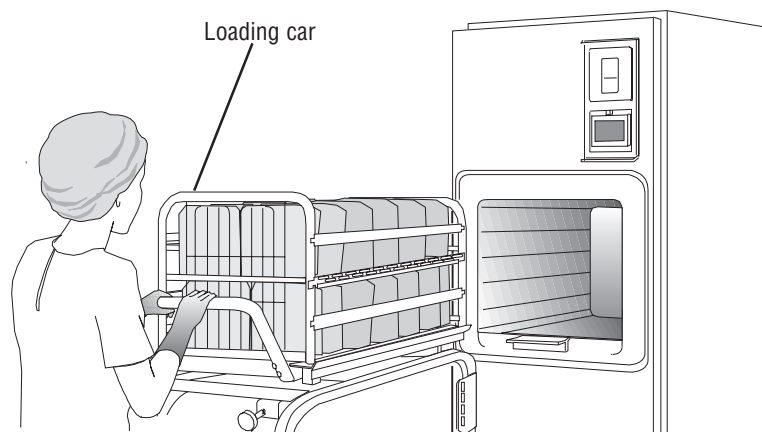



Figure 4-2. Align Loading Car with Chamber Opening

4.6 Loading Car Instructions: Unloading

 **WARNING – BURN HAZARD: Sterilizer, rack/shelves, and loading car will be hot after cycle is run. Always wear protective gloves and apron when removing a processed load. Protective gloves and apron must be worn when reloading sterilizer following the previous operation.**

 **WARNING – PERSONAL INJURY/EQUIPMENT DAMAGE HAZARD: When closing the chamber door, keep hands and arms out of the door opening and verify opening is clear of obstructions.**

NOTE: The loading car and transfer carriage are for use with the 20-inch Century Sterilizer, only.

1. Open chamber door.
2. Move transfer carriage forward until latches engage with track inside chamber.
3. Verify that transfer carriage is latched to track inside chamber by pulling transfer carriage backwards (transfer carriage should remain stationary).
4. Once transfer carriage is latched to track inside chamber, grasp the loading car handle and carefully pull loading car from chamber onto transfer carriage until transfer carriage latch engages to loading car.
5. Disengage transfer carriage latches from track inside chamber by pushing carriage latch knob.
6. Close the chamber door.
7. Transfer load from sterilizer area.

4.7 Loading/ Unloading Sterilizer Equipped With Rack and Shelves

⚠ WARNING – BURN HAZARD: Steam may be released from the chamber when door is opened. Step back from the sterilizer each time the door is opened to minimize contact with steam vapor.

⚠ WARNING – BURN HAZARD: Sterilizer, rack/shelves, and loading car will be hot after cycle is run. Always wear protective gloves and apron when removing a processed load. Protective gloves and apron must be worn when reloading sterilizer following the previous operation.

⚠ WARNING – PERSONAL INJURY/EQUIPMENT DAMAGE HAZARD: When closing the chamber door, keep hands and arms out of the door opening and verify opening is clear of obstructions.

If sterilizer is equipped with the rack and shelves option (see Fig. 4-3), the shelves will slide out halfway to facilitate loading and unloading. Verify rack is returned to chamber before closing door(s).

1. Open chamber door.
2. Transfer load to shelves in chamber. The shelves will slide out half-way to facilitate loading.
3. Slide shelves in after loading. Verify shelf position does not interfere with door operation (both doors if a double door unit).
4. Close the chamber door.
5. The sterilizer is now ready to run a cycle. Proceed to appropriate cycle description found later in this section.
6. Following the successful completion of the sterilize cycle, unload the sterilizer as follows:
 - a. Open chamber door (unloading side).
 - b. Remove load from chamber.
 - c. Slide empty shelves inside chamber to verify shelf position does not interfere with door operation.
 - d. Close chamber door.
 - e. Transfer load from the sterilizer area.

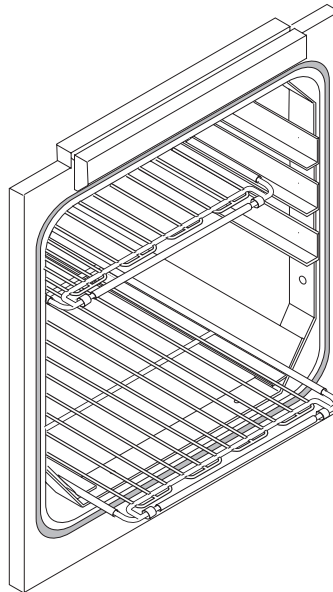

Figure 4-3. Sterilizer Equipped with Rack and Shelves

4.8 Sterilizer (Factory) Cycle Settings

Amsco Century Sterilizers are shipped with the factory-set cycles and cycle values listed in **Table 4-1**.

Table 4-1. Factory-Set Cycles and Cycle Values

PREVACUUM CONFIGURATION

CYCLES:	STERILIZE TEMP.	STERILIZE TIME	DRY TIME	RECOMMENDED LOAD	VALIDATION STANDARD
FLASH	270°F (132°C)	3.0 MIN.	1.0 MIN.	Unwrapped instrument tray with a single instrument.	ST-37
FLASH	270°F (132°C)	10 MIN.	1.0 MIN.	Unwrapped instrument tray with non-porous multiple instruments, max. weight 17 lbs.	ST-37
EXPRESS	270°F (132°C)	4.0 MIN.	3.0 MIN.	Single wrapped instrument tray with a single instrument. Non-porous goods, only.	ST-37
PREVAC	270°F (132°C)	4.0 MIN.	20 MIN. ¹	Up to two double wrapped instrument trays, max. weight 17 lbs each. Up to six fabric packs.	ST-8
PREVAC	275°F (135°C)	3.0 min.	16 min.	Up to two double wrapped instrument tray; max. weight 17 lbs. each.	ST-8

PREVACUUM TESTING CYCLES	STERILIZE TEMP.	STERILIZE TIME	DRY TIME	RECOMMENDED LOAD	VALIDATION STANDARD
LEAK Test ²	270°F (132°C)	N/A	N/A	N/A	ST-8
DART Test ²	270°F (132°C)	3-1/2 MIN.	1.0 MIN.	Bowie-Dick Test or DART	ST-8
DART Warm-up ²	270°F (132°C)	3.0 MIN.	1.0 MIN.	N/A	N/A

¹ Five minute Dry Time can be used for processing a single fabric pack.

² Not adjustable.

NOTE: Prevacuum configuration sterilizers can also be used to run gravity cycles, using the same values as shown for gravity configuration sterilizers.

GRAVITY CONFIGURATION (customer selectable on prevacuum configuration)

CYCLES:	STERILIZE TEMP.	STERILIZE TIME	DRY TIME	RECOMMENDED LOAD	VALIDATION STANDARD
FLASH	270°F (132°C)	3.0 MIN.	1.0 MIN.	Unwrapped instrument tray with a single instrument.	ST-37
FLASH	270°F (132°C)	10 MIN.	1.0 MIN.	Unwrapped instrument tray with non-porous multiple instruments, max. weight 17lbs.	ST-37
GRAVITY	270°F (132°C)	15 MIN.	30 MIN.	Up to two double wrapped instrument trays, max. weight 17 lbs each.	ST-8
GRAVITY	250°F (121°C) ³	30 MIN. ³	15 MIN.	Up to six fabric packs.	ST-8

³A 270°F (132°C) cycle adjusted to 25 minute Sterilize Time can be used for processing Fabric Packs.

4.9 270°F Flash Cycle

WARNING – BURN HAZARD: Sterilizer, rack/shelves, and loading car will be hot after cycle is run. Always wear protective gloves and apron when removing a processed load. Protective gloves and apron must be worn when reloading sterilizer following the previous operation.

WARNING – SLIPPING HAZARD: To prevent falls keep floors dry by immediately wiping up any spilled liquids or condensation in sterilizer loading or unloading area.

WARNING – STERILITY ASSURANCE HAZARD: The Flash cycle is not intended for processing porous items.

CAUTION – POSSIBLE EQUIPMENT DAMAGE: Verify door opening is clear of any obstruction before closing the door(s).

This cycle is for sterilizing an unwrapped item intended for immediate use (e.g., a dropped instrument).

NOTE: Verify item is clean and free of soil.

1. Refer to Section 4.1, *Before Operating the Sterilizer*, before running this cycle.
2. See instructions for using the loading car/transfer carriage or rack and shelves, earlier in this section (Sections 4.5 and 4.6), for procedures to load the sterilizer.
3. When sterilizer is in READY mode, press the appropriate Flash cycle touchscreen pad to begin Flash cycle. Refer to **Table 5-1** for descriptions of cycle use.

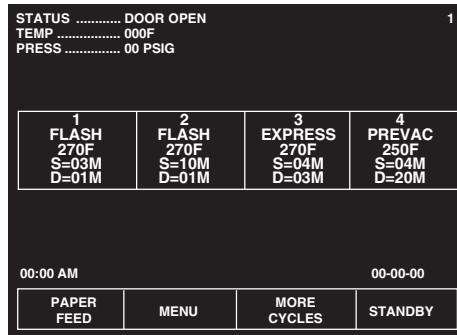

4. Once begun, the sterilizer progresses automatically through the cycle as described below:

NOTE: For more cycle information, note the following:

- 1) If the wrong cycle has been selected, see Section 4.19, *Aborting Cycle*.
- 2) Countdown timer on the display is estimated, timer self-corrects estimated time at the beginning of each phase.

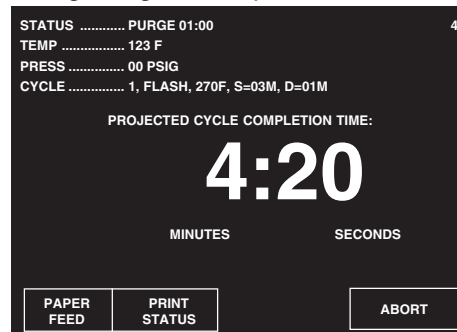

ACTIVATE SEAL — Steam enters the door seal pressing seal against inside surface of door.

PURGE — Chamber is purged with steam. Start of condition is printed.

CHARGE — Chamber is charged with steam. Start of steam charge is printed.



STERILIZE — Start of sterilize exposure is printed when the chamber reaches sterilization temperature. Chamber temperature is printed every minute.



FAST EXHAUST — Start of exhaust is printed and chamber is exhausted to 4.0 psig.

DRY — Start of dry is printed and display counts down dry time remaining. During a Flash cycle, Dry is intended to remove excess steam vapor before opening the door.

NOTE: If zero dry time is selected, the sterilizer still draws a slight vacuum.



AIR BREAK — Chamber is returned to atmospheric pressure.

RETRACT SEAL — A Vacuum is drawn on the seal, retracting it from inner surface of door.

NOTE: If zero dry time is selected, the sterilizer door automatically opens slightly, while the display indicates a vent phase. This allows steam to escape the chamber before unloading

COMPLETE — Complete tone sounds. Cycle summary and end of cycle messages are printed.

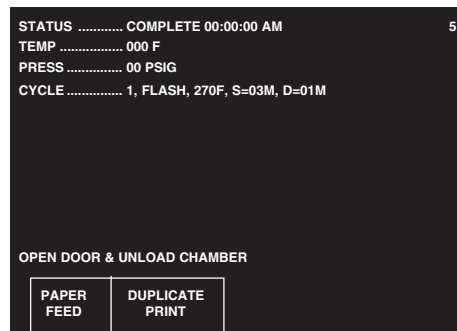

5. Unload sterilizer (see instructions for using the loading car/transfer carriage or rack and shelves, earlier in this section, for procedures to remove load).

Review and verify critical cycle parameters were achieved during processing, then sign printout to indicate verification.

⚠ WARNING – BURN HAZARD: Steam may be released from the chamber when door is opened. Step back from the sterilizer each time the door is opened to minimize contact with steam vapor.

⚠ WARNING – BURN HAZARD: Sterilizer, rack/shelves, and loading car will be hot after cycle is run. Always wear protective gloves and apron when removing a processed load. Protective gloves and apron must be worn when reloading sterilizer following the previous operation.

```

=====
===== F L A S H =====
=====
CYCLE START AT 7:51:20A
                ON 2/16/98

CYCLE COUNT          17
OPERATOR -----
STERILIZER          UAC 00

    STER TEMP = 270.0F
    CONTROL TEMP = 273.0F
    STER TIME = 3 MIN
    DRY TIME = 1 MIN

                U=inHg
- TIME      T= F  P=psia
-----
C 7:51:32A 205.7    0P
C 7:52:32A 249.9   10P
S 7:53:46A 270.0   28P
S 7:54:46A 273.3   30P
S 7:55:46A 272.8   30P
S 7:56:46A 272.8   31P
E 7:56:46A 272.8   31P
E 7:57:09A 231.7    3P
E 7:58:09A 207.0   26U
Z 7:58:55A 211.1    2U

LOAD              021604

    TEMP MAX=273.7F
    TEMP MIN=270.0F

CONDITION   = 2:14
STERILIZE   = 3:00
EXHAUST     = 2:09
TOTAL CYCLE = 7:23

PRINTOUT CHECKED BY:

-----

=====
=  READY TO UNLOAD  =
=====

* NOT READY 8:03:35A
DOOR OPEN

```

Figure 4-4. Typical Printout of a Flash Cycle

4.10 Gravity Cycle

WARNING – BURN HAZARD: Sterilizer, rack/shelves, and loading car will be hot after cycle is run. Always wear protective gloves and apron when removing a processed load. Protective gloves and apron must be worn when reloading sterilizer following the previous operation.

WARNING – SLIPPING HAZARD: To prevent falls keep floors dry by immediately wiping up any spilled liquids or condensation in sterilizer loading or unloading area.

WARNING – PERSONAL INJURY/EQUIPMENT DAMAGE HAZARD: When closing the chamber door, keep hands and arms out of the door opening and verify opening is clear of obstructions.

- 270°F cycle is used for sterilizing double-wrapped instrument trays.
- 250°F cycle is used for sterilizing fabric packs.

NOTE: The cycle shown below is a typical 270°F gravity cycle.

1. Refer to Section 4.1, *Before Operating the Sterilizer*, before running this cycle.
2. See instructions for using the loading car/transfer carriage or rack and shelves, earlier in this section (Sections 4.5 and 4.6), for procedures to load the sterilizer.
3. To start the Gravity cycle, press the appropriate **GRAVITY** touch screen pad. Refer to **Table 5-1** for descriptions of cycle use.
4. Sterilizer automatically progresses through cycle, as follows:

*NOTE: If the wrong cycle has been selected, see Section 4.19, **Aborting Cycle**.*

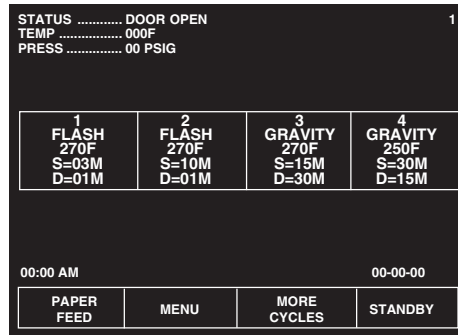

ACTIVATE SEAL — Steam enters the door seal pressing seal against inside surface of door.

PURGE — Chamber is purged with steam. Start of condition is printed.

NOTE: Countdown timer on the display is estimated, timer self-corrects estimated time at the beginning of each phase.

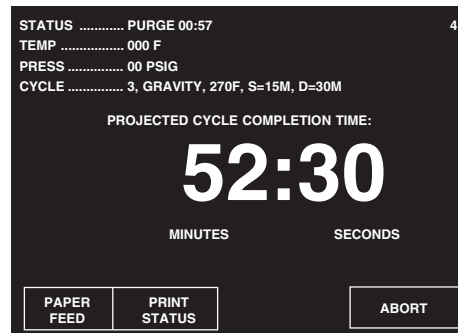

CHARGE — Chamber is charged with steam. Start of steam charge is printed.

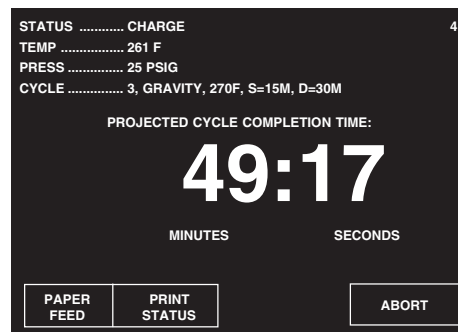

STERILIZE — Start of sterilize exposure is printed when the chamber reaches sterilization temperature. Chamber temperature is printed every minute.



FAST EXHAUST — Start of exhaust is printed and chamber is exhausted to 4.0 psig.

DRY — Start of dry is printed and display counts down dry time remaining.

NOTE: If zero dry time is selected, the sterilizer draws a slight vacuum.

AIR BREAK — Chamber is returned to atmospheric pressure.



RETRACT SEAL — A vacuum is drawn on the seal, retracting it from inner surface of door.

NOTE: If zero dry time is selected, the sterilizer door automatically opens slightly, while the display indicates a vent phase. This allows steam vapors to escape the chamber before unloading.

WARNING – BURN HAZARD: Steam may be released from the chamber when door is opened. Step back from the sterilizer each time the door is opened to minimize contact with steam vapor.

WARNING – BURN HAZARD: Sterilizer, rack/shelves, and loading car will be hot after cycle is run. Always wear protective gloves and apron when removing a processed load. Protective gloves and apron must be worn when reloading sterilizer following the previous operation.

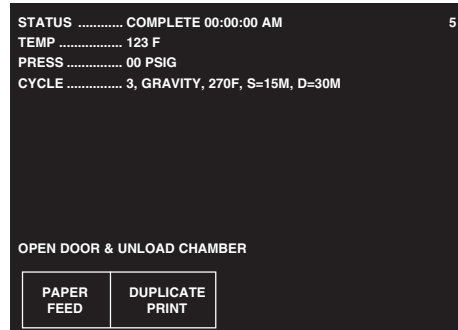

COMPLETE — Complete tone sounds. Cycle summary and end of cycle messages are printed.

5. Unload sterilizer (see instructions for using the loading car/transfer carriage or rack and shelves, earlier in sections 4.5 and 4.6 for procedures to remove load).

Review and verify critical cycle parameters were achieved during processing, then sign printout to indicate verification.

```

===== G R A V I T Y =====
=====
CYCLE START AT 11:09:14A
                ON 2/16/98

CYCLE COUNT      23
OPERATOR -----
STERILIZER      VAC 00

    STER TEMP = 270.0F
    CONTROL TEMP = 273.0F
    STER TIME = 15 MIN
    DRY TIME = 30 MIN

                U=inHg
- TIME          T= F  P=psia
-----
C 11:09:26A 191.3    1P
C 11:10:27A 248.1    10P
S 11:12:10A 270.0    29P
S 11:13:10A 273.4    31P
S 11:14:10A 273.3    31P
S 11:15:10A 272.8    30P
S 11:16:10A 273.3    31P
S 11:17:10A 273.3    31P
S 11:18:10A 273.0    31P
S 11:19:10A 273.2    30P
S 11:20:10A 272.8    31P
S 11:21:10A 273.0    30P
S 11:22:10A 273.0    30P
S 11:23:10A 273.1    30P
S 11:24:10A 273.3    30P
S 11:25:10A 273.0    30P
S 11:26:10A 273.3    30P
E 11:27:10A 272.8    30P
E 11:27:32A 231.8    3P
E 11:57:33A 197.9    27U
Z 11:58:19A 199.5    2U

LOAD              021610

    TEMP MAX=273.7F
    TEMP MIN=270.0F

CONDITION   = 2:44
STERILIZE   =15:00
EXHAUST     =31:09
TOTAL CYCLE =48:53

PRINTOUT CHECKED BY:

=====
=  READY TO UNLOAD  =
=====

* NOT READY    11:58:50A
DOOR OPEN
=====

```

Figure 4-5. Typical Printout of a Gravity Cycle

4.11 270°F Express Cycle

WARNING – BURN HAZARD: Sterilizer, rack/shelves, and loading car will be hot after cycle is run. Always wear protective gloves and apron when removing a processed load. Protective gloves and apron must be worn when reloading sterilizer following the previous operation.

WARNING – SLIPPING HAZARD: To prevent falls keep floors dry by immediately wiping up any spilled liquids or condensation in sterilizer loading or unloading area.

WARNING – STERILITY ASSURANCE HAZARD: The Express cycle is only intended for use with a single instrument in a single wrapped instrument tray.

WARNING – STERILITY ASSURANCE HAZARD: The Express cycle is not intended for processing porous items (except the tray wrapper).

WARNING – PERSONAL INJURY/EQUIPMENT DAMAGE HAZARD: When closing the chamber door, keep hands and arms out of the door opening and verify opening is clear of obstructions.

This cycle is for sterilizing a single instrument in a single-wrapped instrument tray (e.g., dropped instrument).

NOTE: For more cycle information, note the following:

- 1) Verify item is clean and free of soil.
- 2) This cycle is available for Century prevacuum sterilizers, only. Refer to Section 2.2, Special Information Regarding the Express Cycle before running an Express cycle.
1. Refer to Section 4.1, Before Operating the Sterilizer, before running this cycle.
2. See instructions for using the loading car/transfer carriage or rack and shelves, earlier in this section (Sections 4.5 and 4.6), for procedures to load the sterilizer.
3. Press **EXPRESS** touch screen pad to start the Express cycle. Refer to **Table 5-1** for descriptions of cycle use.
4. Sterilizer automatically progresses through cycle, as follows:

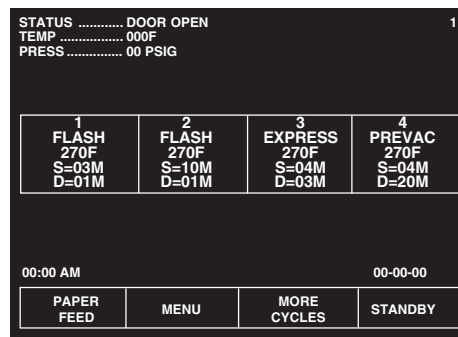

NOTE: If the wrong cycle has been selected, see Section 4.19, Aborting Cycle.

ACTIVATE SEAL — Steam enters the door seal pressing seal against inside surface of door.

PURGE — Chamber is purged with steam. Start of condition is printed.

NOTE: Countdown timer on the display is estimated, timer self-corrects estimated time at the beginning of each phase.

PULSE #1 (and **PULSE #2**) — Vacuum point is printed and pressure/vacuum pulse is repeated.

CHARGE — Chamber is charged with steam. Start of steam charge is printed.

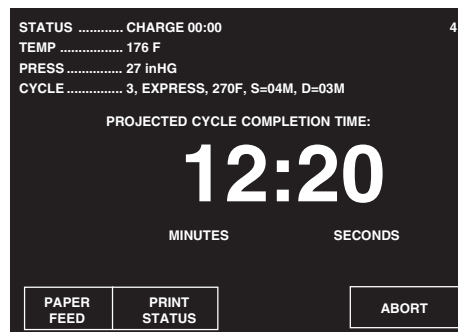

STERILIZE — Start of sterilize exposure is printed when the chamber reaches sterilization temperature. Chamber temperature is printed every minute.

FAST EXHAUST — Start of exhaust is printed and chamber is exhausted to 4.0 psig.



DRY — Start of dry is printed and display counts down dry time remaining.



AIR BREAK — Chamber is returned to atmospheric pressure.

RETRACT SEAL — A vacuum is drawn on the seal, retracting it from inner surface of door.

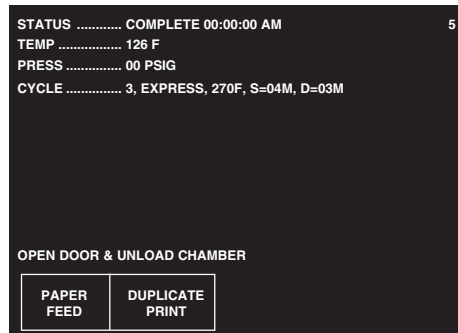

COMPLETE — Complete tone sounds. Cycle summary and end of cycle messages are printed.

5. Unload sterilizer (see instructions for using the loading car/transfer carriage or rack and shelves, earlier in sections 4.5 and 4.6 for procedures to remove load).

Review and verify critical cycle parameters were achieved during processing, then sign printout to indicate verification.

⚠ WARNING – BURN HAZARD: Steam may be released from the chamber when door is opened. Step back from the sterilizer each time the door is opened to minimize contact with steam vapor.

⚠ WARNING – BURN HAZARD: Sterilizer, rack/shelves, and loading car will be hot after cycle is run. Always wear protective gloves and apron when removing a processed load. Protective gloves and apron must be worn when reloading sterilizer following the previous operation.

```

=====
==== E X P R E S S ====
=====
CYCLE START AT 8:19:42A
                ON 2/16/98

CYCLE COUNT      19
OPERATOR -----
STERILIZER       UAC 00

    STER TEMP = 270.0F
    CONTROL TEMP = 273.0F
    STER TIME = 4 MIN
    DRY TIME = 3 MIN

- TIME          T=F    U=inHg  P=psia
-----
C 8:19:54A 216.2    1P
C 8:20:54A 251.2   10P
C 8:22:01A 200.9   16V
C 8:22:29A 260.2   26P
C 8:23:45A 216.2   26V
S 8:24:23A 270.0   29P
S 8:25:23A 273.3   33P
S 8:26:23A 273.0   33P
S 8:27:23A 273.5   33P
S 8:28:23A 273.5   32P
E 8:28:23A 273.4   32P
E 8:28:46A 230.9    3P
E 8:31:46A 212.2   27V
Z 8:32:33A 212.4    2V

LOAD              021606

    TEMP MAX=273.9F
    TEMP MIN=270.0F

CONDITION   = 4:29
STERILIZE   = 4:00
EXHAUST     = 4:10
TOTAL CYCLE =12:39

PRINTOUT CHECKED BY:

=====
=  READY TO UNLOAD  =
=====

* NOT READY      8:42:51A
DOOR OPEN
-----

```

Figure 4-6. Typical Printout of an Express Cycle

4.12 270°F Prevac Cycle

WARNING – BURN HAZARD: Sterilizer, rack/shelves, and loading car will be hot after cycle is run. Always wear protective gloves and apron when removing a processed load. Protective gloves and apron must be worn when reloading sterilizer following the previous operation.

WARNING – SLIPPING HAZARD: To prevent falls keep floors dry by immediately wiping up any spilled liquids or condensation in sterilizer loading or unloading area.

WARNING – PERSONAL INJURY/EQUIPMENT DAMAGE HAZARD: When closing the chamber door, keep hands and arms out of the door opening and verify opening is clear of obstructions.

This cycle is used for sterilizing double-wrapped instrument trays or fabric packs.

NOTE: This cycle is only available on prevacuum configuration sterilizers.

1. Refer to Section 4.1, *Before Operating the Sterilizer*, before running this cycle.
2. See instructions for using the loading car/transfer carriage or rack and shelves, earlier in this section (Sections 4.5 and 4.6), for procedures to load the sterilizer.
3. Press **PREVAC** touch screen pad to start the Prevacuum cycle. Refer to **Table 5-1** for descriptions of cycle use.
4. Sterilizer automatically progresses through cycle, as follows:

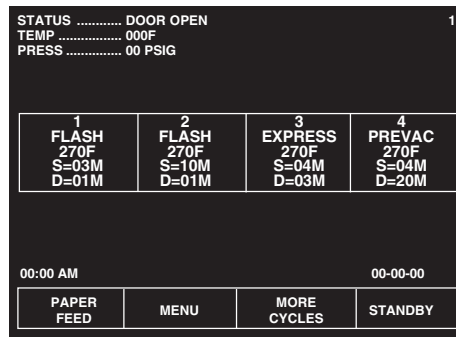

NOTE: If the wrong cycle has been selected, see Section 4.19, *Aborting Cycle*.

ACTIVATE SEAL — Steam enters the door seal, pressing seal against inside surface of door.

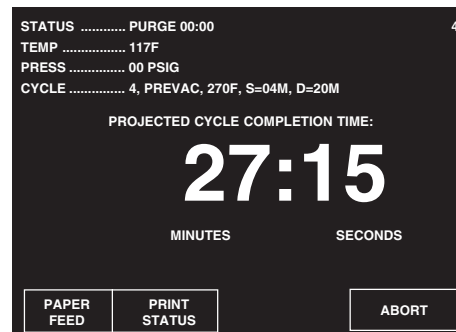

PURGE — Chamber is purged with steam. Start of condition is printed.

NOTE: Countdown timer on the display is estimated, timer self-corrects estimated time at the beginning of each phase.

PRESSURE/VACUUM PULSES #1 – #4 — Vacuum point is printed and pressure/vacuum pulse is repeated.

CHARGE — Chamber is charged with steam. Start of steam charge is printed.

STERILIZE — Start of sterilize exposure is printed when the chamber reaches sterilization temperature. Chamber temperature is printed every minute.

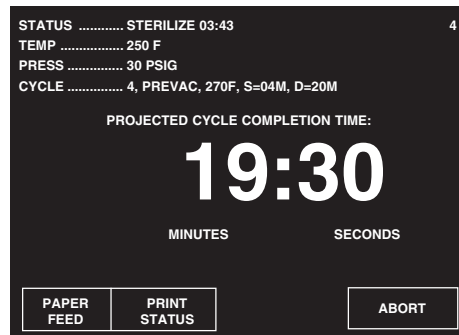

FAST EXHAUST — Start of exhaust is printed and chamber is exhausted to four psig.

DRY — Start of dry is printed and display counts down dry time remaining.



AIR BREAK — Chamber is returned to atmospheric pressure.

RETRACT SEAL — A vacuum is drawn on the seal, retracting it from inner surface of door.

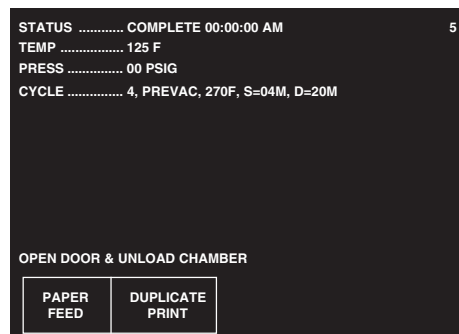

COMPLETE — Complete tone sounds. Cycle summary and end of cycle messages are printed.

5. Unload sterilizer (see instructions for using the loading car/transfer carriage or rack and shelves, earlier in section 4.5 and 4.6 for procedures to remove load).

Review and verify critical cycle parameters were achieved during processing, then sign printout to indicate verification.

! WARNING – BURN HAZARD: Steam may be released from the chamber when door is opened. Step back from the sterilizer each time the door is opened to minimize contact with steam vapor.

! WARNING – BURN HAZARD: Sterilizer, rack/shelves, and loading car will be hot after cycle is run. Always wear protective gloves and apron when removing a processed load. Protective gloves and apron must be worn when reloading sterilizer following the previous operation.

```

=====
===== P R E V A C =====
=====
CYCLE START AT  8:43:23A
                ON  2/16/98

CYCLE COUNT          20
OPERATOR _____
STERILIZER          UAC 00

    STER TEMP = 270.0F
    CONTROL TEMP = 273.0F
    STER TIME =  4 MIN
    DRY TIME = 20 MIN

                U=inHg
- TIME          T= F  P=psia
-----
C  8:43:35A 196.6   0P
C  8:44:35A 251.0  10P
C  8:45:42A 222.2  16V
C  8:46:13A 265.7  26P
C  8:47:31A 198.1  26V
C  8:47:57A 256.8  26P
C  8:49:13A 215.3  26V
C  8:49:40A 260.0  26P
C  8:50:57A 216.5  27V
S  8:51:33A 270.0  28P
S  8:52:33A 273.3  32P
S  8:53:33A 272.6  31P
S  8:54:33A 272.8  31P
S  8:55:33A 273.3  31P
E  8:55:33A 273.3  31P
E  8:55:54A 234.4   3P
E  9:15:55A 198.5  27V
Z  9:16:41A 200.1   2V

LOAD              021607

    TEMP MAX=273.9F
    TEMP MIN=270.0F

CONDITION   = 7:58
STERILIZE   = 4:00
EXHAUST     =21:08
TOTAL CYCLE =33:06

PRINTOUT CHECKED BY:

-----
=====
=  READY TO UNLOAD  =
=====

* NOT READY      9:32:56A
DOOR OPEN
-----

```

Figure 4-7. Typical Printout of a Prevac Cycle

4.13 275°F Prevac Cycle

WARNING – BURN HAZARD: Sterilizer, rack/shelves, and loading car will be hot after cycle is run. Always wear protective gloves and apron when removing a processed load. Protective gloves and apron must be worn when reloading sterilizer following the previous operation.

WARNING – SLIPPING HAZARD: To prevent falls keep floors dry by immediately wiping up any spilled liquids or condensation in sterilizer loading or unloading area.

WARNING – PERSONAL INJURY/EQUIPMENT DAMAGE HAZARD: When closing the chamber door, keep hands and arms out of the door opening and verify opening is clear of obstructions.

This cycle is used for sterilizing double-wrapped instrument trays or fabric packs:

NOTE: This cycle is only available on prevacuum configuration sterilizers.

1. Refer to Section 4.1, *Before Operating the Sterilizer*, before running this cycle.
2. See instructions for using the loading car/transfer carriage or rack and shelves, earlier in the section (Sections 4.5 and 4.6), for procedures to load the sterilizer.
3. Press **PREVAC** touch screen pad to start the Prevacuum cycle. Refer to **Table 6-5** for descriptions of cycle use.
4. Sterilizer automatically progresses through cycles, as follows:

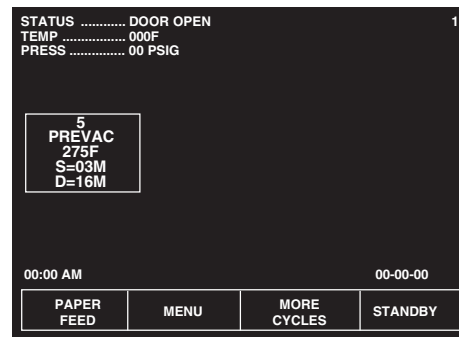

NOTE: If the wrong cycle has been selected, see section 4.19, Aborting Cycle.

ACTIVATE SEAL — Steam enters the door seal, pressing seal against inside surface of door.

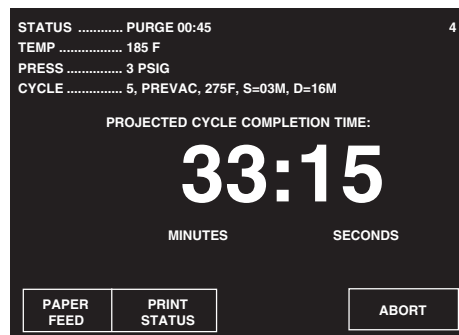

PURGE — Chamber is purged with steam . Start of condition is printed.

NOTE: Countdown timer on the display is estimated, timer self-corrects estimated time at the beginning of each phase.

PRESSURE/VACUUM PULSES #1 – #3 — Vacuum point is printed and pressure/vacuum pulse is repeated.

CHARGE — Chamber is charged with steam . Start of steam charge is printed.

STERILIZE — Start of sterilize exposure is printed when the chamber reaches sterilization temperature. Chamber temperature is printed every minute.



FAST EXHAUST — Start of exhaust is printed and chamber is exhausted to four psig.

DRY — Start of dry is printed and display counts down dry time remaining.



AIR BREAK — Chamber is returned to atmospheric pressure.

RETRACT SEAL — A vacuum is drawn on the seal, retracting it from inner surface of door.

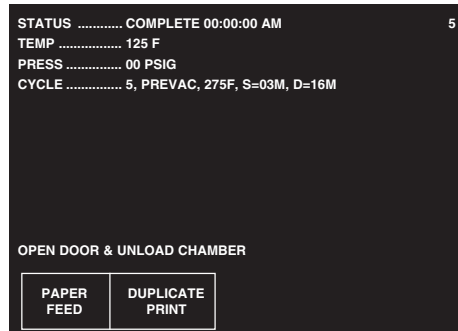

COMPLETE — Complete tone sounds. Cycle summary and end of cycle messages are printed.

5. Unload sterilizer (see instructions for using the loading car/transfer carriage or rack and shelves, earlier in this section for procedures to remove load.)

Review and verify critical cycle parameters were achieved during processing, then sign printout to indicate verification.

WARNING – BURN HAZARD: Steam may be released from the chamber when door is opened. Step back from the sterilizer each time the door is opened to minimize contact with steam vapor.

WARNING – BURN HAZARD: Sterilizer, rack/shelves, and loading car will be hot after cycle is run. Always wear protective gloves and apron when removing a processed load. Protective gloves and apron must be worn when reloading sterilizer following the previous operation.

```

=====
===== P R E V A C =====
=====
CYCLE START AT 2:28:10P
ON 10/01/02

CYCLE COUNT          70
OPERATOR _____
STERILIZER          UAC 00

STER TEMP = 275.0F
CONTROL TEMP = 278.0F
STER TIME = 3 MIN
DRY TIME = 16 MIN

                U=inHg
- TIME          T= F  P=psia
-----
C 2:28:23P 186.4   0.2P
C 2:29:23P 221.3   6.6P
C 2:32:08P 186.9  10.0U
C 2:34:01P 270.4  30.1P
C 2:35:39P 166.6  18.1U
C 2:36:50P 266.0  30.1P
C 2:38:28P 156.7  20.3U
S 2:41:23P 275.0  33.9P
S 2:42:23P 278.1  35.6P
S 2:43:23P 278.1  35.5P
S 2:44:23P 278.2  35.1P
E 2:44:23P 278.2  35.1P
E 2:45:03P 226.5   3.8P
E 3:01:04P 206.2  26.4U
Z 3:02:04P 203.1   2.0U

LOAD              100107

TEMP MAX=278.4F
TEMP MIN=275.0F

CONDITION   =13:00
STERILIZE   = 3:00
EXHAUST     =17:41
TOTAL CYCLE =33:41

PRINTOUT CHECKED BY:

-----
=====
=  READY TO UNLOAD  =
=====

* NOT READY      3:02:32P
DOOR OPEN
-----

```

Figure 5-8. Typical Printout — 275°F Prevac Cycle

4.14 DART (Bowie-Dick) Test (Prevacuum Sterilizer only)

WARNING – BURN HAZARD: Sterilizer, rack/shelves, and loading car will be hot after cycle is run. Always wear protective gloves and apron when removing a processed load. Protective gloves and apron must be worn when reloading sterilizer following the previous operation.

WARNING – PERSONAL INJURY/EQUIPMENT DAMAGE HAZARD: When closing the chamber door, keep hands and arms out of the door opening and verify opening is clear of obstructions.

This cycle is used to conduct a Bowie-Dick test on the sterilizer.

Tests such as the DART (Daily Air Removal Test) or Bowie-Dick are designed to document the removal of residual air from a sample challenge load (see Section 2.4.2, *Testing For Prevacuum Efficiency*). Refer to Section 2, *Sterilization Techniques* when constructing the Bowie-Dick test pack. A DART (Bowie-Dick test) cycle should be run daily before processing any loads. The chamber must be at operating temperature when DART (Bowie-Dick test) cycle is performed. The DART Warm-up cycle should be completed prior to performing DART (Bowie-Dick test) cycle.

1. Refer to Section 4.1, *Before Operating the Sterilizer*, and to Section 2, *Sterilization Techniques*, to prepare the unit for running this cycle.
2. Press **MORE CYCLES** touch screen pad at the cycle selection menu to access the second screen of cycles. Press **DART TEST** touch screen pad.
3. A second menu then appears on the screen. A DART test should only be run in a machine that is at operating temperature (that is, has run one or more cycles). If the sterilizer has not run any cycles prior to the DART test, run the DART WARM-UP cycle.

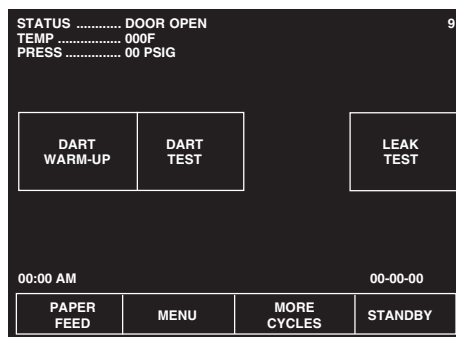

- a. The operator is prompted to close the chamber door, if it is open. Once closed, the door seals automatically.
 - b. The sterilizer automatically runs a cycle with three minute sterilize and one minute dry values.
 - c. Once the Warm-up cycle is complete, the display returns to cycle select menu.
4. Open the chamber door (if it is not already open). Load the DART indicator and close the door.
 5. Start the DART cycle. The cycle runs automatically, as follows:

ACTIVATE SEAL — Steam enters the door seal, pressing seal against inside surface of door.

PURGE — Chamber is purged with steam. Start of condition is printed.

PULSE #1 through **PULSE #4** — Vacuum point is printed and pressure/vacuum pulse is repeated.

CHARGE — Chamber is charged with steam. Start of steam charge is printed.

STERILIZE — Start of sterilize exposure is printed when the chamber reaches set temperature. Chamber temperature is printed every minute. Chamber is controlled at set point plus overdrive.

FAST EXHAUST — Start of exhaust is printed and chamber is exhausted to 4.0 psig.

DRY — Start of dry is printed and display counts down dry time remaining.

AIR BREAK — Chamber is returned to atmospheric pressure.

RETRACT SEAL — A vacuum is drawn on the seal, retracting it from inner surface of door.

COMPLETE — Complete tone sounds. Cycle summary and end of cycle messages are printed.

Review and verify critical cycle parameters were achieved during processing, then sign printout to indicate verification.

6. Once the cycle is complete:
 - a. Open the chamber door by pressing on the foot pedal.
 - b. Unload the DART test pack.
 - c. Refer to instructions packaged with DART indicator. Forward the exposed test strip to the appropriate personnel for examination.

WARNING – BURN HAZARD: Steam may be released from the chamber when door is opened. Step back from the sterilizer each time the door is opened to minimize contact with steam vapor.

```
=====
=== D A R T   T E S T ===
=====
CYCLE START AT 7:31:54A
                ON 2/16/98

CYCLE COUNT          16
OPERATOR -----
STERILIZER    UAC 00

    STER TEMP = 270.0F
    CONTROL TEMP = 273.0F
    STER TIME = 3.5 MIN
    DRY TIME = 1 MIN

                U=inHg
- TIME          T= F  P=psia
-----
C 7:32:06A 209.7    1P
C 7:33:06A 247.1   10P
C 7:34:15A 204.3   16U
C 7:34:48A 260.8   26P
C 7:36:08A 203.6   27U
C 7:36:37A 256.1   26P
C 7:37:56A 202.1   27U
C 7:38:25A 257.7   26P
C 7:39:44A 208.9   27U
S 7:40:36A 270.0   30P
S 7:41:36A 272.6   31P
S 7:42:37A 273.3   31P
S 7:43:36A 273.5   31P
E 7:44:07A 273.2   32P
E 7:44:29A 232.7    3P
E 7:45:30A 209.2   27U
Z 7:46:16A 211.3    2U

LOAD                021603

    TEMP MAX=274.0F
    TEMP MIN=270.0F

CONDITION   = 8:30
STERILIZE   = 3:31
EXHAUST     = 2:09
TOTAL CYCLE =14:10

PRINTOUT CHECKED BY:

-----
=====
=  READY TO UNLOAD  =
=====

* NOT READY    7:50:53A
DOOR OPEN
-----
```

Figure 4-9. Typical Printout of a DART Cycle

4.15 Vacuum Leak Test (Prevacuum Sterilizer only)

WARNING— STERILITY ASSURANCE HAZARD: According to AAMI standards, a measured leak rate greater than 1.0 mm Hg/minute indicates a problem with the sterilizer. Refer the situation to a qualified service technician before using the sterilizer further.

WARNING— PERSONAL INJURY/EQUIPMENT DAMAGE HAZARD: When closing the chamber door, keep hands and arms out of the door opening and verify opening is clear of obstructions.

This cycle is used for testing vacuum integrity of the sterilizer's piping.

A Vacuum Leak Test cycle should be run on the sterilizer at least once each week. In this cycle, the sterilizer automatically checks for vacuum leaks in the piping and door seal. If the sterilizer fails the leak test, it must be inspected by a service technician. This test is not a substitute for a Bowie-Dick test. The leak test can also be used to confirm that the sterilizer piping is intact after performing repairs.

NOTE: The measured leak rate (mm Hg per minute) is calculated by the control over a timed 10 minute period and is included in the cycle printout. A leak rate of 1.0 mm Hg/minute or less is considered acceptable.

1. Before running leak test cycle, refer to Section 4.1, *Before Operating the Sterilizer*.
2. Press **MORE CYCLES**. The leak test cycle touch screen pad appears on the display.
3. To start the leak test press the **LEAK TEST** touch screen pad. Printer records cycle start. Cycle runs automatically as follows:

NOTE: Cycle requires 25-35 minutes to complete.

ACTIVATE SEAL — Steam enters the door seal, pressing seal against inside surface of door.

PURGE — Chamber is purged; printer records end of purge.

PULSE #1 (and **PULSE #2**) — Two vacuum and pressure pulses then occur and printer records each.

CHARGE — After the pressure pulses, temperature rises to 270°F (132°C), unit begins to draw a vacuum for 10 minutes. (Printer records temperature and pressure at beginning of 10 minute vacuum time.)

LEAK TEST/EVACUATING — Printer records temperature and vacuum at end of evacuation time.

LEAK TEST/STABILIZING — Two minute stabilization period begins after 10 minute evacuation is completed.

LEAK TEST — Ten minute leak test period begins after two minute stabilization is completed. Printer records calculated leak rate (mm Hg per minute) after ten minute leak time.

AIR BREAK — Chamber is returned to atmospheric pressure, complete tone sounds and cycle summary and end of cycle messages are printed.

RETRACT SEAL — A vacuum is drawn on the seal, retracting it from inner surface of door.

COMPLETE — Complete tone sounds. Cycle summary and end of cycle messages are printed.

Review and verify critical cycle parameters were achieved during processing, then sign printout to indicate verification.

4. Once the sterilizer completes and passes the leak test, the unit can be used.

```

=====
=== L E A K   T E S T ===
=====
CYCLE START AT  9:33:26A
                ON  2/16/98

CYCLE COUNT          21
OPERATOR  _____
STERILIZER    UAC 00

                U=inHg
- TIME          T= F  P=psig
-----
C  9:33:38A 190.5    1P
C  9:34:39A 248.1    9P
C  9:35:45A 215.4   15U
C  9:36:23A 265.9   26P
C  9:37:41A 173.7   26U
L  9:39:12A 270.0   32P
L  9:49:36A 203.7   27U
L  9:51:36A 200.9   27U
L 10:01:36A 195.8   27U
LEAK RATE IS:
  0.1 mmHg/min

L 10:01:36A 195.8   27U
E 10:01:37A 195.8   27U
Z 10:02:23A 197.7   2U

LOAD                021608

TOTAL CYCLE =28:45

PRINTOUT CHECKED BY:

-----
=====

```

Figure 4-10. Typical Printout of a Leak Test Cycle

4.16 Optional Liquid Cycle

WARNING – EXPLOSION HAZARD: This sterilizer is not designed to process flammable compounds.

WARNING – BURN HAZARD: When sterilizing liquids, to prevent personal injury or property damage resulting from bursting bottles and hot fluid, you must observe the following procedures:

- Use Liquid cycle only; no other cycle is safe for processing liquids.
- Use only vented closures; do not use screw caps or rubber stoppers with crimped seal.
- Use only Type I borosilicate glass bottles; do not use ordinary glass bottles or any container not designed for sterilization.
- Do not allow hot bottles to be jolted; this can cause hot-bottle explosions. Do not move bottles if any boiling or bubbling is present.

WARNING – BURN HAZARD: It is inappropriate for a health care facility to sterilize liquids for direct patient contact.

CAUTION – POSSIBLE EQUIPMENT DAMAGE: Sterilization of chloride-containing solutions (e.g., saline) can cause chamber corrosion and is not recommended by the manufacturer. If, however, chloride-containing solutions must be processed, clean the chamber after each use.

This cycle is used for sterilizing liquids in vented closures.

1. Refer to Section 4.1, *Before Operating the Sterilizer*, before running this cycle.
2. See instructions for using the loading car/transfer carriage or rack and shelves, earlier in sections 4.5 and 4.6, for procedures to load the sterilizer.
3. Press **LIQUID** touch screen pad to start the Liquid cycle.
4. Sterilizer automatically progresses through cycle, as follows:

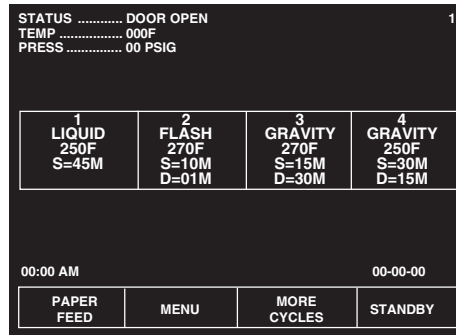

NOTE: If the wrong cycle has been selected, see Section 4.19, Aborting Cycle.

ACTIVATE SEAL — Steam enters the door seal pressing seal against inside surface of door.

PURGE — Chamber is purged with steam. Start of condition is printed.

NOTE: Countdown timer on the display is estimated, timer self-corrects estimated time at the beginning of each phase.

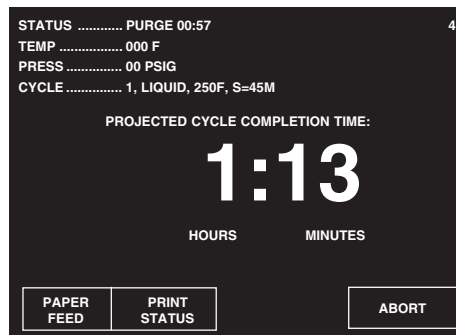

CHARGE — Chamber is charged with steam. Start of steam charge is printed.

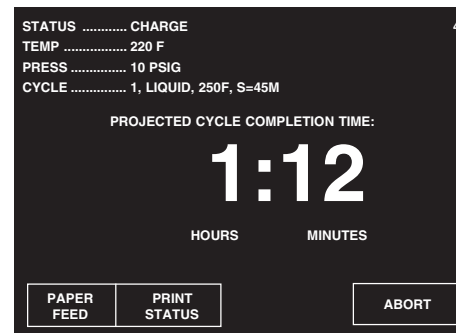

STERILIZE — Start of sterilize exposure is printed when the chamber reaches sterilization temperature. Chamber temperature is printed every five minutes.



SLOW EXHAUST — Start of exhaust is printed and chamber is exhausted to 0.0 psig.



SLOW EVACUATE — A vacuum is slowly drawn in the chamber to 5.0 in Hg. This phase assures that the chamber is cooled to 208°F/95°C.

VAPOR REMOVAL — Filtered air enters the chamber to relieve the vacuum within the chamber. Steam is exhausted from the door seal. Chamber vapor vents, through slight opening between seal and door, into the sterilizer cabinet for six minutes.

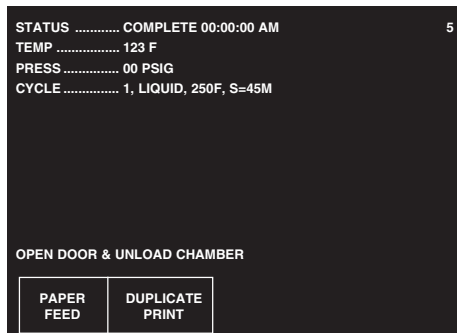

COMPLETE — Complete tone sounds. Cycle summary and end of cycle messages are printed.

5. Unload sterilizer (see instructions for using the loading car/transfer carriage or rack and shelves, in sections 4.5 and 4.6 for procedures to remove load).

Review and verify critical cycle parameters were achieved during processing, then sign printout to indicate verification.

⚠ WARNING – BURN HAZARD: Steam may be released from the chamber when door is opened. Step back from the sterilizer each time the door is opened to minimize contact with steam vapor.

⚠ WARNING – BURN HAZARD: Sterilizer, rack/shelves, and loading car will be hot after cycle is run. Always wear protective gloves and apron when removing a processed load. Protective gloves and apron must be worn when reloading sterilizer following the previous operation.

```

=====
===== L I Q U I D =====
=====
CYCLE START AT 11:43:56A
                ON 2/18/98

CYCLE COUNT          24
OPERATOR -----
STERILIZER    UAC 00

        STER TEMP = 250.0F
        CONTROL TEMP = 253.0F
        STER TIME = 45 MIN

                U=inHg
- TIME          T= F  P=psia
-----
C 11:44:09A  171.5    0P
C 11:45:09A  237.7    9P
S 11:45:49A  250.1    17P
S 11:50:49A  253.2    18P
S 11:55:49A  253.0    17P
S 12:00:49P  253.0    17P
S 12:05:49P  253.2    18P
S 12:10:49P  253.4    18P
S 12:15:49P  253.4    18P
S 12:20:49P  253.2    18P
S 12:25:49P  253.0    18P
E 12:30:49P  253.3    17P
V 12:49:37P  201.5    5V
Z 12:56:05P  185.7    0V

LOAD                021801

        TEMP MAX=254.7F
        TEMP MIN=250.1F

CONDITION   = 0:01:40
STERILIZE   = 0:45:00
EXHAUST     = 0:25:16
TOTAL CYCLE = 1:11:56

PRINTOUT CHECKED BY:

-----

=====
=  READY TO UNLOAD  =
=====

* NOT READY    2:38:47P
DOOR OPEN
-----

```

Figure 4-11. Typical Printout of a Liquid Cycle

4.17 Sterilization Techniques for Optional Liquid Cycle

IMPORTANT: It is inappropriate for a healthcare facility to sterilize liquids for direct patient contact.

Refer to **Table 4-2** for recommended Liquid cycle parameters. The recommended times indicated in **Table 4-2** assume the use of vented bottles. The "minimum sterilization time" includes the time required to bring the solution up to the sterilize temperature plus the time required to achieve sterilization.

Table 4-2. Liquid Cycle Parameters

Volume of Liquid in One Container	Minimum Recommended Sterilize Time at 250°F (121°C) in minutes	No. of Containers
1000 mL	45	3

⚠ WARNING – EXPLOSION HAZARD: This sterilizer is not designed to process flammable compounds.

⚠ WARNING – BURN HAZARD: When sterilizing liquids, to prevent personal injury or property damage resulting from bursting bottles and hot fluid, you must observe the following procedures:

- Use Liquid cycle only; no other cycle is safe for processing liquids.
- Use only vented closures; do not use screw caps or rubber stoppers with crimped seal.
- Use only Type I borosilicate glass bottles; do not use ordinary glass bottles or any container not designed for sterilization.
- Do not allow hot bottles to be jolted; this can cause hot-bottle explosions. Do not move bottles if any boiling or bubbling is present.

⚠ WARNING – BURN HAZARD: It is inappropriate for a health care facility to sterilize liquids for direct patient contact.

⚠ CAUTION – POSSIBLE EQUIPMENT DAMAGE: Sterilization of chloride-containing solutions (e.g., saline) can cause chamber corrosion and is not recommended by the manufacturer. If, however, chloride-containing solutions must be processed, clean the chamber after each use.

4.18 Recommendations for Sterilizing Liquids

⚠ WARNING – EXPLOSION HAZARD: This sterilizer is not designed to process flammable compounds.

⚠ WARNING – BURN HAZARD: When sterilizing liquids, to prevent personal injury or property damage resulting from bursting bottles and hot fluid, you must observe the following procedures:

- Use Liquid cycle only; no other cycle is safe for processing liquids.
- Use only vented closures; do not use screw caps or rubber stoppers with crimped seal.
- Use only Type I borosilicate glass bottles; do not use ordinary glass bottles or any container not designed for sterilization.
- Do not allow hot bottles to be jolted; this can cause hot-bottle explosions. Do not move bottles if any boiling or bubbling is present.

⚠ WARNING – BURN HAZARD: It is inappropriate for a health care facility to sterilize liquids for direct patient contact.

⚠ CAUTION – POSSIBLE EQUIPMENT DAMAGE: Sterilization of chloride-containing solutions (e.g., saline) can cause chamber corrosion and is not recommended by the manufacturer. If, however, chloride-containing solutions must be processed, clean the chamber after each use.

IMPORTANT: Please read the following paragraphs before sterilizing any liquids in your sterilizer. It is inappropriate for a health care facility to sterilize liquids for direct patient contact.

Borosilicate glass is required because it is a superior glass capable of resisting thermal shock. If glass not as thermally resistant is used, a greater potential for bursting exists.

Vented closures are required because, by design, they release internal pressure build-up by automatically venting the containers, whereas pressure in unvented containers remains until the contents have cooled. Examples of vented closures are shown in Figure 4-12.

Sterilizing liquids in any other type of container or with the use of non-vented closures requires a sterilizer specifically designed for that purpose.

When loading, place small bottles in a separate basket to minimize sliding. Always use side rails on the loading car to prevent containers or baskets from falling off.

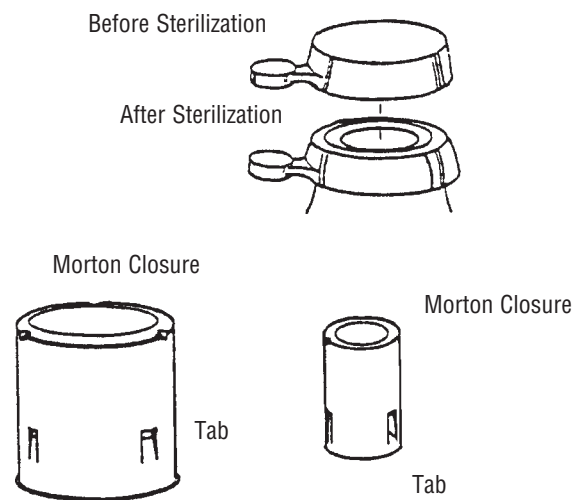

Figure 4-12. Vented Closures

4.19 Aborting Cycles

WARNING – BURN HAZARD: Steam may be released from the chamber when door is opened. Step back from the sterilizer each time the door is opened to minimize contact with steam vapor.

WARNING – BURN HAZARD: Sterilizer, rack/shelves, and loading car will be hot after cycle is run. Always wear protective gloves and apron when removing a processed load. Protective gloves and apron must be worn when reloading sterilizer following the previous operation.

It may be necessary to end a processing cycle, possibly because the wrong cycle was selected or the sterilizer begins functioning incorrectly. A cycle can be aborted at any time during processing by pressing the **ABORT** touch screen pad.

1. Touch the **ABORT** touch screen pad.
 - The status line on the display changes to EXHAUSTING CHAMBER, if there is pressure in the chamber.
 - The sterilizer exhausts the chamber of steam.

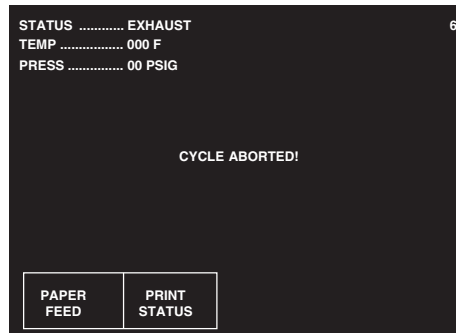

2. Once chamber reaches 4.0 psig, the sterilizer removes vapor from the chamber for one minute.
3. Once vapor removal is over, status line changes to COMPLETE. When complete the sterilizer chamber can be unloaded following the instructions earlier in this section of the manual.

4.20 Cycle Graphs

These cycle graphs provide a visual representation of Century Sterilizer cycles and their phases.

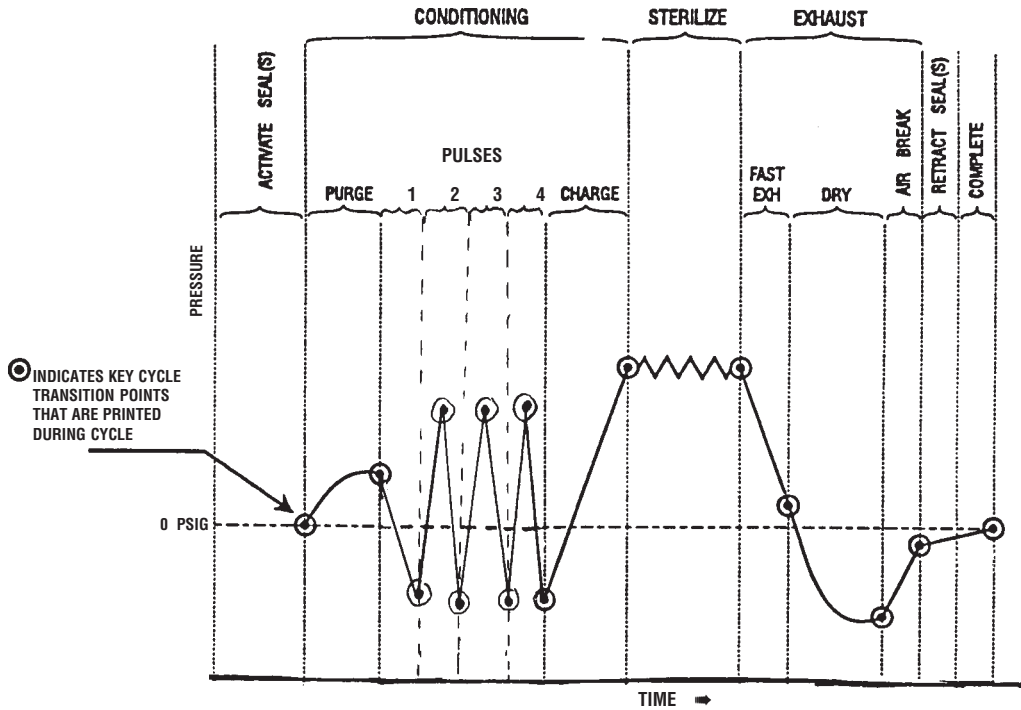

Figure 4-13. Cycle Graph - 270°F Prevacuum and DART Cycles

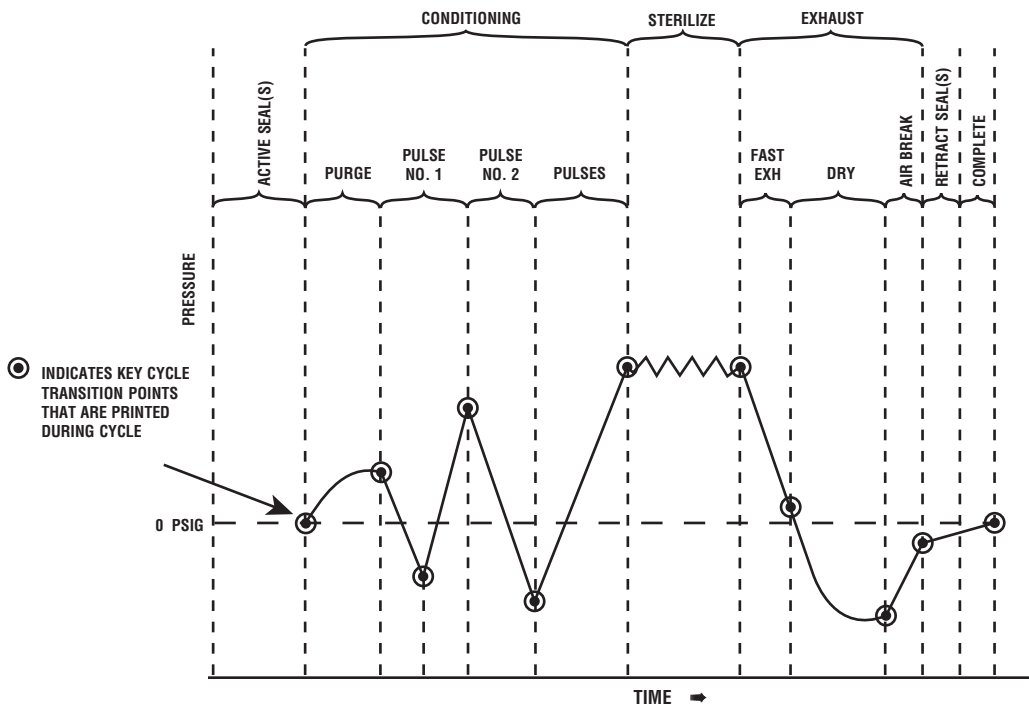

Figure 4-14. Cycle Graph - Express Cycle

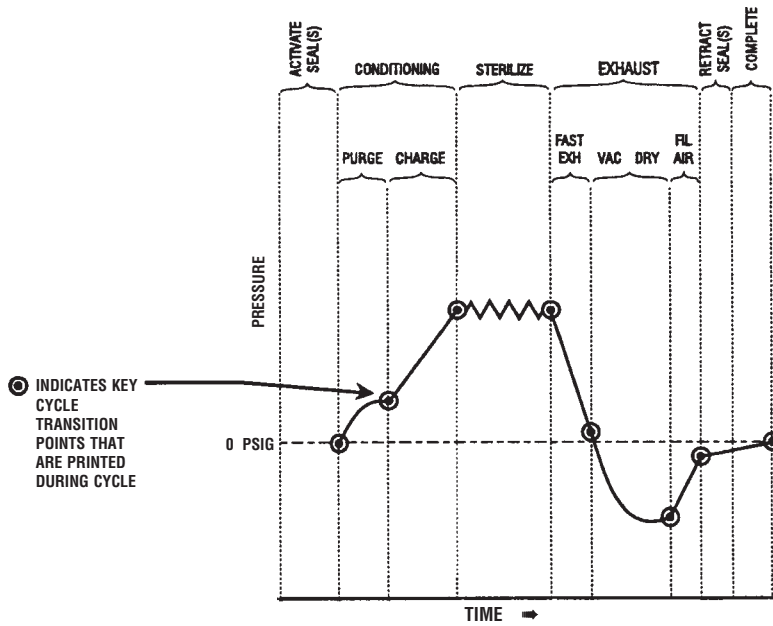

Figure 4-15. Cycle Graph - Gravity and Flash Cycles

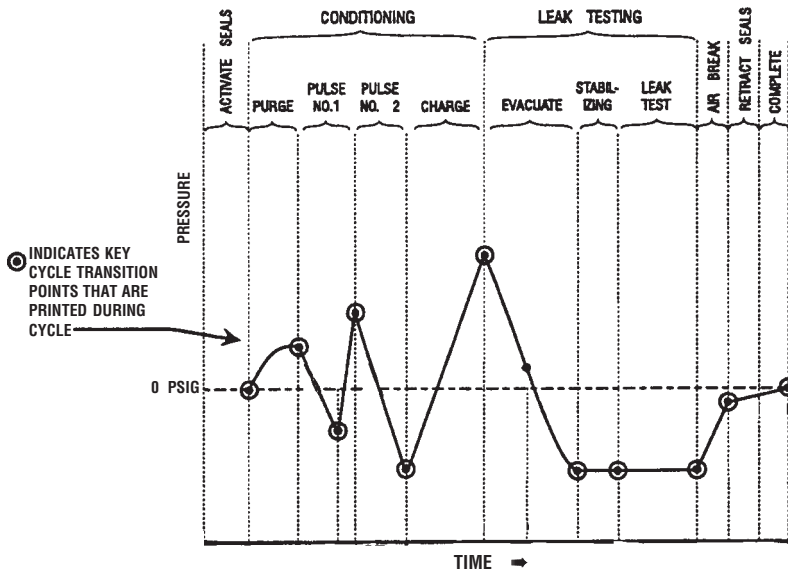

Figure 4-16. Cycle Graph - Leak Test

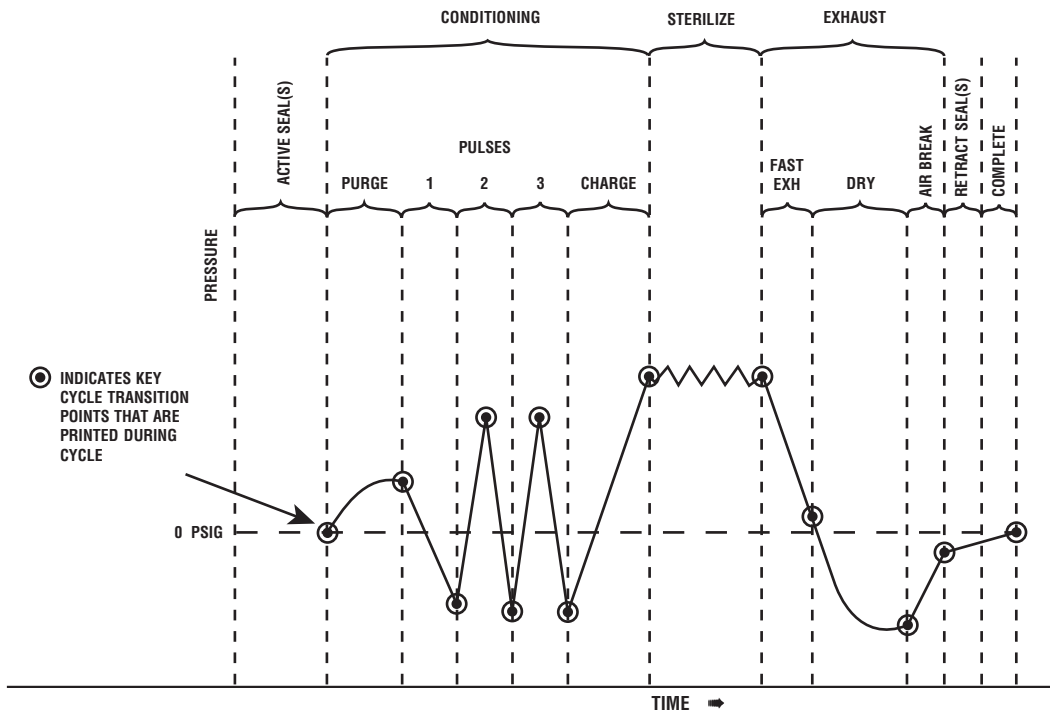

Figure 4-17. Cycle Graph - 275°F Prevacuum Cycle

Amsco® Century® sterilizers are shipped with factory-set cycles, cycle values and control values programmed into the control (see **Table 5-1**). These are the cycles and values to which the control will default should a battery or battery-powered memory failure ever occur. To adjust cycle values, refer to procedures later in this section.

NOTE: *If a battery or memory failure should occur, any customer-adjusted cycles would be lost. The factory-set cycles and cycle values would then appear on the display when the sterilizer power is switched ON.*

IMPORTANT: The cycles listed in **Table 5-1** have been validated using the techniques documented in AAMI ST-8 and AAMI ST-37. If different cycle parameters (sterilize time or dry time) are required, it is the responsibility of the health care facility to validate the cycle. Reference appropriate AAMI guidelines for validating sterilization cycles to assure the proper Sterility Assurance Level (SAL) as well as moisture retention acceptance criteria.

Table 5-1. Cycle Availability

Cycle Type	Load	Sterilize Temperature	Sterilize Time	Dry Time	Prevac		Gravity	
					Default	Optional	Default	Optional
Gravity*	Full Load Fabric Packs	270°F	25 min	15 min		X		X
Gravity*	Full Load Fabric Packs	250°F	30 min	15 min		X	X	
Gravity*	Full Load Instrument Trays	270°F	15 min	30 min		X	X	
Gravity*	Full Load Instrument Trays	250°F	30 min	30 min		X		X
Liquid*	Three 1000ml Bottles	250°F	45 min	N/A		X		X
Prevac*	Single Fabric Pack	270°F	4 min	5 min		X	N/A	N/A
Prevac*	Full Load Instrument Trays	270°F	4 min	20 min	X		N/A	N/A
Prevac*	Full Load Instrument Trays	275°F	3 min	16 min	X		N/A	N/A
Flash**	Unwrapped, Non-porous Instrument Tray	270°F	3 min	1 min	X		X	
Express**	Single-wrapped Instrument Tray	270°F	4 min	3 min	X		N/A	N/A
Flash	Unwrapped, Non-porous Instrument Tray	270°F	10 min	1 min	X		X	
DART*	Bowie-Dick Test Pack	270°F	3½ min	1 min	X		N/A	N/A
Leak* Test	None	N/A	N/A	N/A	X		N/A	N/A

*Cycles qualified to AAMI ST-8

**Cycles qualified to AAMI ST-37

5.1 Sterilizer (Factory) Cycle Settings

Amsco Century Sterilizers are shipped with the factory-set cycles and cycle values listed in **Table 5-2**.

Table 5-2. Factory-Set Cycles and Cycle Values

PREVACUUM CONFIGURATION

CYCLES:	STERILIZE TEMP.	STERILIZE TIME	DRY TIME	RECOMMENDED LOAD	VALIDATION STANDARD
FLASH	270°F (132°C)	3.0 MIN.	1.0 MIN.	Unwrapped instrument tray with a single instrument.	ST-37
FLASH	270°F (132°C)	10 MIN.	1.0 MIN.	Unwrapped instrument tray with non-porous multiple instruments, max. weight 17 lbs.	ST-37
EXPRESS	270°F (132°C)	4 MIN.	3.0 MIN.	Single wrapped instrument tray with a single instrument. Non-porous goods, only.	ST-37
PREVAC	270°F (132°C)	4 MIN.	20 MIN. ¹	Up to two double wrapped instrument trays, max. weight 17 lbs each. Up to six fabric packs.	ST-8
PREVAC	275°F (135°C)	3.0 min.	16 min.	Up to two double wrapped instrument tray; max. weight 17 lbs. each.	ST-8

PREVACUUM TESTING CYCLES	STERILIZE TEMP.	STERILIZE TIME	DRY TIME	RECOMMENDED LOAD	VALIDATION STANDARD
LEAK Test ²	270°F (132°C)	N/A	N/A	N/A	ST-8
DART Test ²	270°F (132°C)	3-1/2 MIN.	1.0 MIN.	Bowie-Dick Test or DART	ST-8
DART Warm-up ²	270°F (132°C)	3.0 MIN.	1.0 MIN.	N/A	N/A

¹ Five minute Dry Time can be used for processing a single fabric pack.

² Not adjustable.

NOTE: Prevacuum configuration sterilizers can also be used to run gravity cycles, using the same values as shown for gravity configuration sterilizers.

GRAVITY CONFIGURATION (customer selectable on prevacuum configuration)

CYCLES:	STERILIZE TEMP.	STERILIZE TIME	DRY TIME	RECOMMENDED LOAD	VALIDATION STANDARD
FLASH	270°F (132°C)	3.0 MIN.	1.0 MIN.	Unwrapped instrument tray with a single instrument.	ST-37
FLASH	270°F (132°C)	10 MIN.	1.0 MIN.	Unwrapped instrument tray with non-porous multiple instruments, max. weight 17lbs.	ST-37
GRAVITY	270°F (132°C)	15 MIN.	30 MIN.	Up to two double wrapped instrument trays, max. weight 17 lbs each.	ST-8
GRAVITY	250°F (121°C) ³	30 MIN. ³	15 MIN.	Up to six fabric packs.	ST-8

³A 270°F (132°C) cycle adjusted to 25 minute Sterilize Time can be used for processing Fabric Packs.

5.2 Change Values

CAUTION – POSSIBLE EQUIPMENT DAMAGE: If zero dry time is selected, sterilizer automatically initiates a vapor removal phase in place of drying. This phase can still draw a vacuum to 5.0 inHg. Consult device manufacturer's recommendations to ensure devices being processed can withstand this depth of vacuum.

The Change Values procedure can be used to adjust the following values:

- Sterilization Exposure Time
- Dry Time.
- Change Values can also be used to make adjustments to the Change Machine Setup values shown on **Table 5-3**.

The default cycle values for gravity and prevacuum configuration sterilizers are shown on **Table 5-1**. Refer to **Table 4-2** for recommended exposure times when sterilizing liquids.

IMPORTANT: The cycles listed in **Table 5-1** have been validated using the techniques documented in AAMI ST-8. If different cycle parameters (sterilize time or dry time) are required, it is the responsibility of the health care facility to validate the cycle. Reference appropriate AAMI guidelines for validating sterilization cycles to assure the proper Sterility Assurance Level (SAL) as well as moisture retention acceptance criteria

The Change Values touch screens are accessed by pressing the **CHANGE VALUES** touch screen pad (see Screen #2). All Change Values options can be secured (or locked out) using a supervisor's access code. It is recommended that supervisor's Access Code be used to prevent unauthorized personnel from changing cycle and system setup parameters.

NOTE: Temperature units: Amsco Century sterilizers are factory shipped set to operate using degrees Fahrenheit.

All changes are made to displayed settings using touch screens. No mechanical adjustments to the sterilizer are necessary.

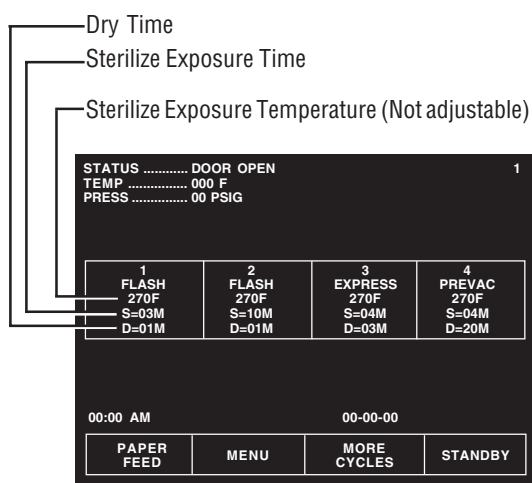

Factory Set Cycles for Prevacuum Configuration

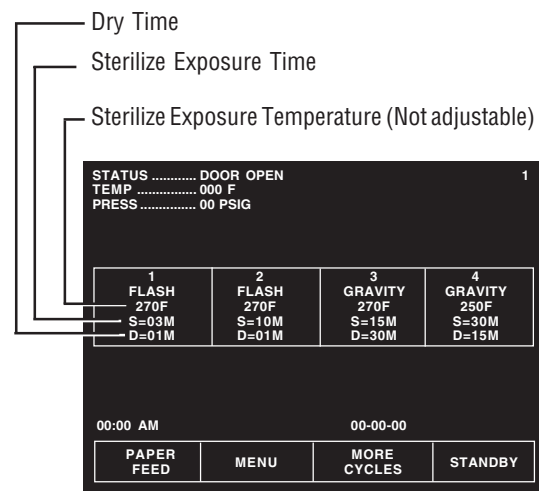

Factory Set Cycles for Gravity Configuration

5.3 Change Cycle Values

5.3.1 Overview

Refer to Figure 5-1. Press the **ON** touch screen pad, if the sterilizer is in STANDBY. The control advances to Status screen (#1). At screen #1, press the **MENU** touch screen pad, and the control advances to screen #2; access the cycle values by pressing **CHANGE CYCLE VALUES**. Pressing **CHANGE CYCLE VALUES** advances the control to screen #10, prompting the operator to select a cycle to change. Press one of the displayed cycles, or **MORE CYCLES** to find a cycle not currently on the display. Once the cycle has been found and selected, the screen changes to show basic cycle information. Select the value to change: **NAME** (name of the cycle), **STER** (sterilize exposure time), or **DRY** (drying phase time). Press the touch screen pad; the display changes to a screen for making these changes. Once all selections have been made, press the **EXIT** touch screen pad.

5.3.2 Step by Step

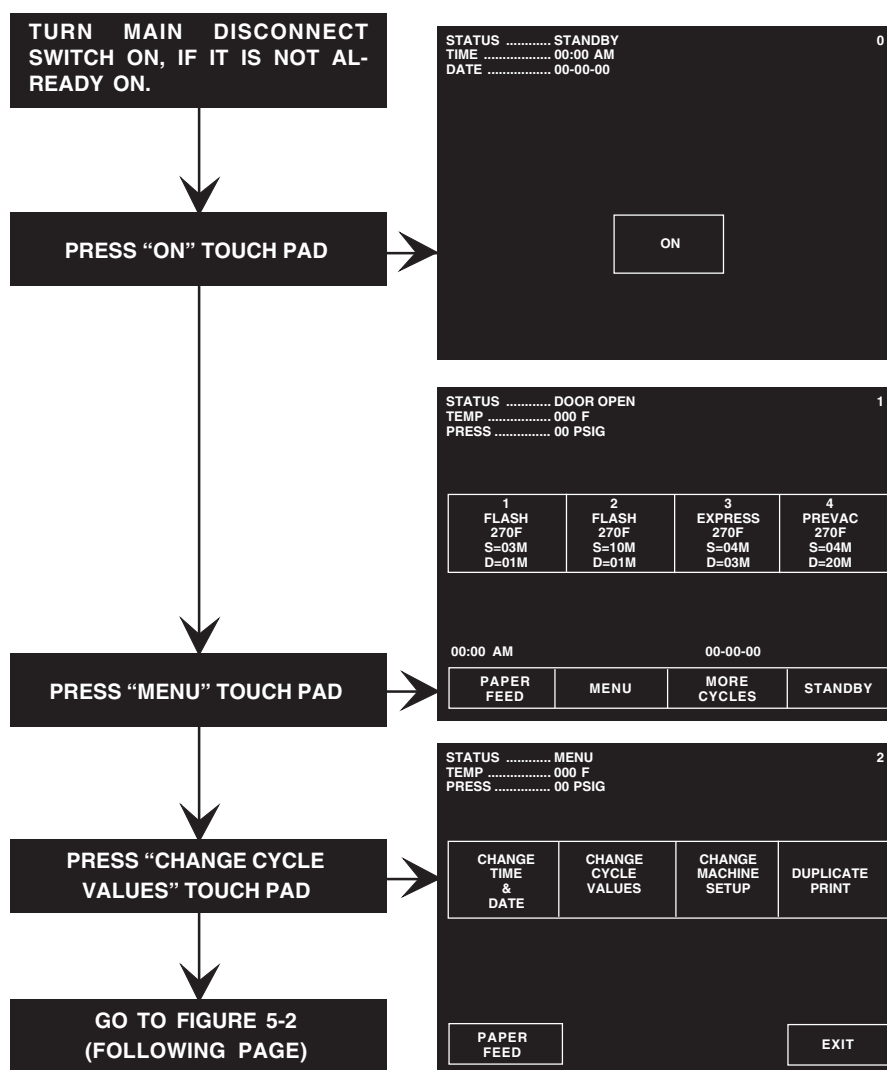

Figure 5-1. Accessing Change Cycle Values

(NOTE: Figure 5-2, below, is a continuation of the flow chart in Figure 5-1.)

Pressing EXIT causes the sterilizer to leave Change Values, saving any changes made to the point where EXIT was pressed.

A printout of cycle values and the cycle count is provided by pressing PRINT VALUES. Any changed cycle values and the cycle count are automatically printed after returning to screen #10 from screen #11.

If cycle is locked out, Access Code Screen (#37) appears. The access code must be entered using the following procedure:

- If the code is known, enter it using the touch screen key pad. Once the entire four digit code has been entered, press the ENTER touch screen pad. The access code digits are not displayed.
- If the code is not known, press CANCEL to return to the previous screen.

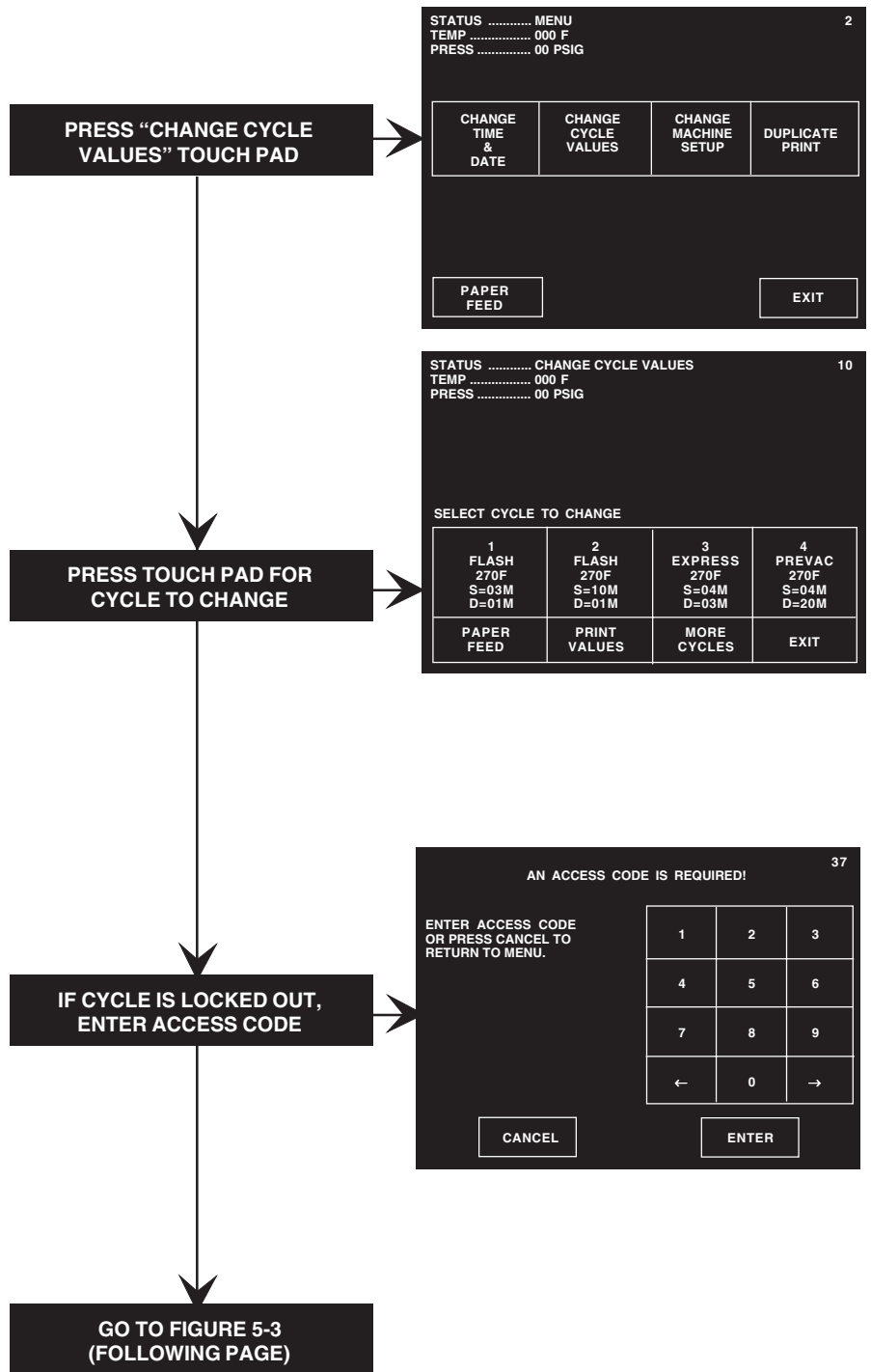

Figure 5-2. Change Cycle Values

(NOTE: Figure 5-3, below, is a continuation of the flow chart in Figure 5-2.)

It is possible to change the cycle type (by pressing NAME touch pad), Sterilization Exposure Time (by pressing STER touch pad), or Drying Time (by pressing DRY touch pad).

STER or DRY values can be entered or changed using the numeric touch pads. Arrow touch pads move the cursor position (for editing) left or right. Refer to Section 5.4, Adjusting Sterilize Time and Dry Time, for additional information.

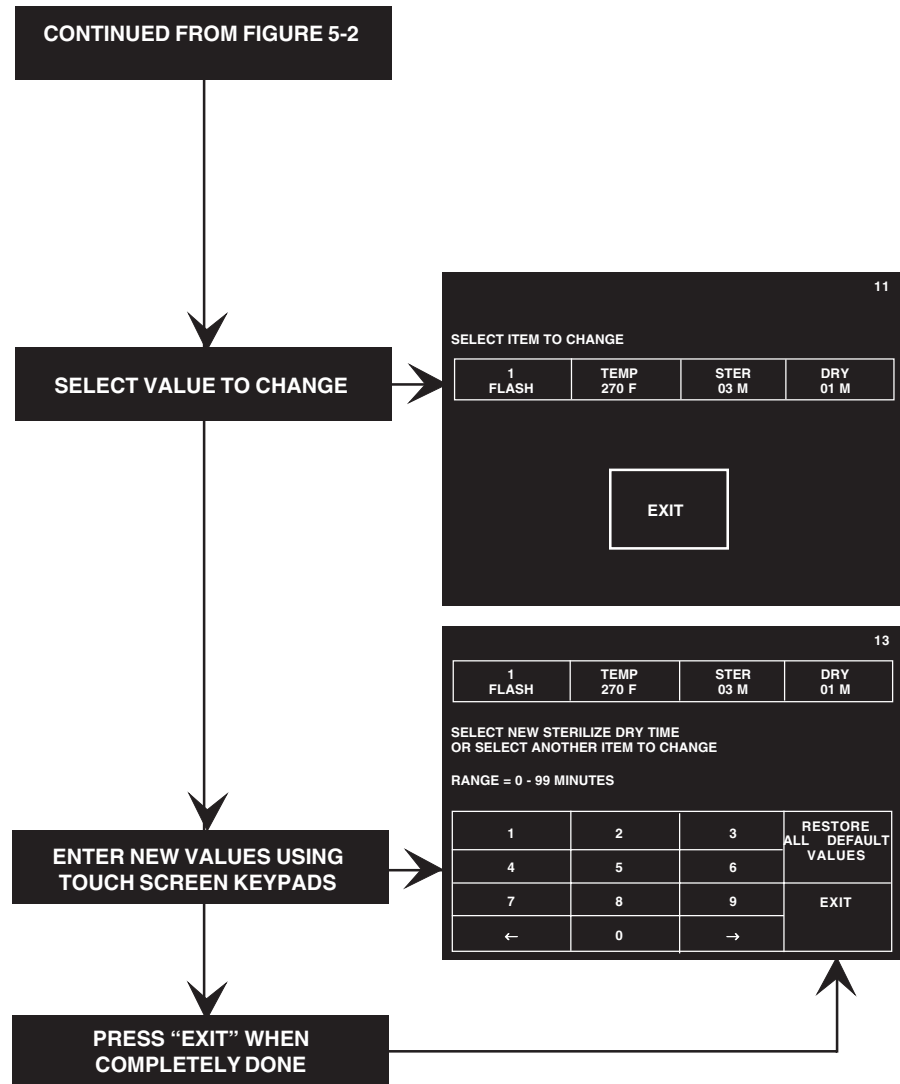

Figure 5-3. Change Cycle Values, Continued

5.4 Adjusting Sterilize Time And Dry Time

The following selections can be adjusted:

- **NAME:** For changing the cycle type.
 - » Prevacuum Configuration – FLASH, GRAVITY, EXPRESS or PREVAC.
 - » Gravity Configuration – FLASH or GRAVITY.

NOTE: When selecting a name, all other cycle values default to the factory set values for that cycle.

12			
1 GRAVITY	TEMP 270 F	STER 15 M	DRY 30 M
SELECT NEW CYCLE NAME OR SELECT ANOTHER ITEM TO CHANGE			
PREVAC	GRAVITY	EXPRESS	FLASH
NONE			EXIT

- **STER:** For changing the sterilization exposure time. Use number touch pads to enter a new value. Left and right arrow touch pads can be used to cursor through an existing value.

13			
1 GRAVITY	TEMP 270 F	STER 15 M	DRY 30 M
SELECT NEW STERILIZE TIME OR SELECT ANOTHER ITEM TO CHANGE			
RANGE = 0 - 99 MINUTES			
1	2	3	RESTORE ALL DEFAULT VALUES
4	5	6	
7	8	9	EXIT
←	0	→	

left and right arrow touch pads

- **DRY:** For changing the dry time.

NOTE: To return cycle values to original state, press RESTORE ALL DEFAULT VALUES. This touch pad can also be used to cancel previous changes to a cycle.

Once all values for the selected cycle have been adjusted, press **EXIT** to save new values and return to the cycle selection display. Upon leaving Change Values the control prints the changed cycle values.

5.5 Change Time and Date

These screens adjust the time and date the sterilizer uses for all display and printout messages.

NOTE: Change Time and Date feature cannot be locked out under the Access Code feature.

The current time and date appears on the Off/Standby screen (#0) and Status screen (#1) screens. Time and date are also shown on printouts. These should be verified periodically. To change:

1. At screen #1, press **MENU** touch screen pad. This brings the Menu screen (#2) onto the display.
2. At screen #2, press **CHANGE TIME & DATE**. The display advances to screen #31.

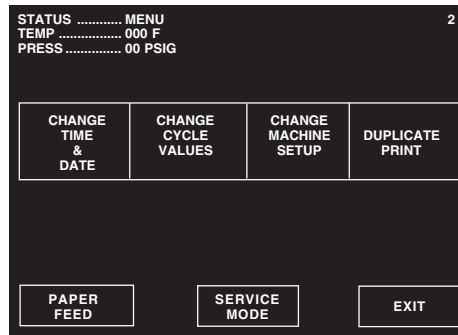

3. Make adjustments using procedures shown on following page.

NOTE: In the following procedures the selected option is always illustrated with a bright background and dark characters.

- **TIME:** At screen #31 the **TIME** touch screen pad is highlighted. Enter the correct time using the touch key pads.
 - a. Press the number key pads to enter hours and minutes. For example, 10:45 would be entered by pressing **1 0 4 5**.
 - b. Press **AM** or **PM** key pad as appropriate.
 - c. If an incorrect number is entered, press **TIME** to start over, or use the cursor key pads at the bottom of the screen to backup to an incorrect number.
 - d. Once the correct time has been entered, press **DATE** to adjust the date, or press **EXIT** to return to Status screen (#1).



- **DATE:** At screen #31, press **DATE** and screen #32 appears with the DATE touch screen pad highlighted. Enter the correct date using the touch key pads.

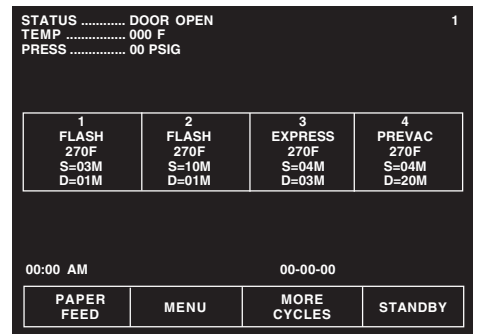
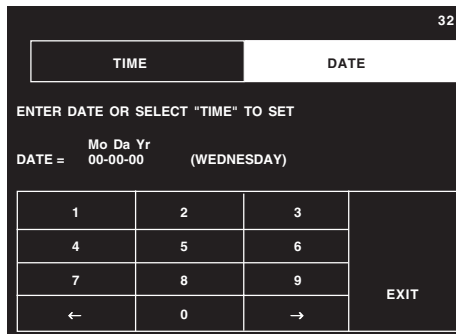

- a. Press the number key pads to enter month, day and year. For example, June 15, 1993 would be entered by pressing **0 6 1 5 9 3**.
- b. If an incorrect number is entered, press **DATE** again to start over, or use the cursor key pads at the bottom of the screen to backup to an incorrect number.
- c. Once the correct date has been entered, press **EXIT** to return to screen #1.

NOTE: The day of the week is automatically registered by the control.

5.6 Change Machine Setup

The Setup options are used to change the way the sterilizer operates in a general way. An Access Code can be enabled and by doing so, all or some of these options can be secured or “locked out” by the supervisor (see Access Code later in this section for more information on Access Code). All Setup options are accessed from the Setup Menu.

A summary of the setup options that can be adjusted are listed in **Table 5-3**. Each value is detailed in this section.

Table 5-3. Change Machine Setup

MACHINE SETUP	
Access Code	Once the access code has been set, all cycles values and change values options can be selected to lockout, making them unavailable for change by an operator without entering the access code.
Lockout	This setting is used to secure any of the Change Values options under the access code. Once a function is locked out, the Access Code must be entered before the setting can be accessed or changed.
Utilities Control	This setting permits the operator to program the sterilizer to automatically shut off its steam and water at the end of the work day, to conserve utilities. Shut down and power-up times can be programmed for any time of the day on weekdays or the weekend.
Language	This option can be used to select one of three factory set languages as the default for displays and printouts. Available languages are ENGLISH, SPANISH and FRENCH. A BILINGUAL options allows for easy changes between English and Spanish, or English and French.
Machine Number	This is used to assign a two character, alphanumeric code to the sterilizer. This code appears in the heading of all printouts. If this option is set to a value between 1 and 9, cycle complete tone sounds the set number of times.
Time Format	This setting allows the control to display times using either standard AM/PM format or 24 hour format (military time).
Print Format	This setting allows the sterilizer to print a condensed version of the cycle printout to conserve on paper usage.
Audible Signals	This option allows adjustment of ALARM, END OF CYCLE and TOUCH PAD signals tones. Tones can be independently adjusted to one of three volume levels. ALARM signal tone cannot be turned off.
Units	This is used to select the temperature and pressure units displayed and printed out by the sterilizer. The sterilizer is capable of displaying temperature as either Fahrenheit or Celsius; pressure can be displayed as psig/inHg or in bar*. * Bar is displayed and printed as Pbar and Vbar. When the pressure is above atmospheric, it is shown as Pbar. When the pressure is below atmospheric, it is shown as Vbar.
Date Format	The sterilizer can be programmed to change the way the date is displayed and printed. The normal setting is to display Month/Day/Year (M/D/Y); but this can be changed to Year/Month/Day (Y/M/D), or Day/Month/Year (D/M/Y).
Duplicate Print	Sterilizer can be set to automatically furnish a duplicate printout of each cycle at the end of the cycle. First line will always read — DUPLICATE PRINT — and complete printout of cycle data will be furnished.

5.7 Access Code

This setup option is used to control access to the adjustment functions of the Century control. When the Access Code is turned on, a four digit code must be entered before any locked out functions can be changed. The functions locked out are selected by the supervisor or operator.

1. To access this utility, press **CHANGE MACHINE SETUP** touch screen pad from the Menu screen at the operating end of the sterilizer.

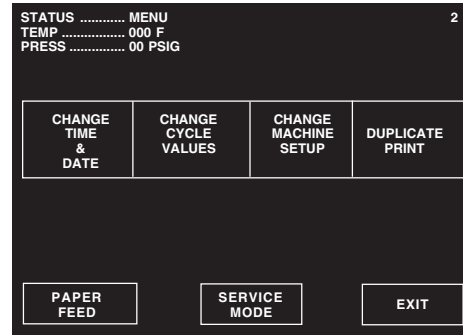

2. The display changes to the Change Machine Setup screen. Press the touch screen pad labeled **ACCESS CODE**. The screen changes to the Access Code screen (#21).

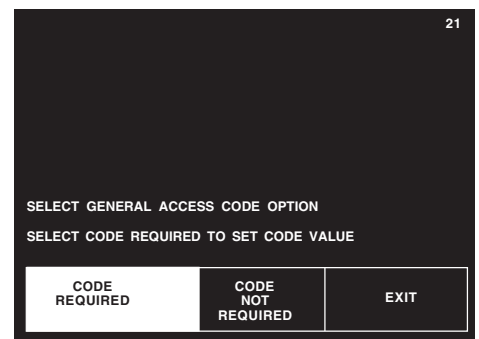
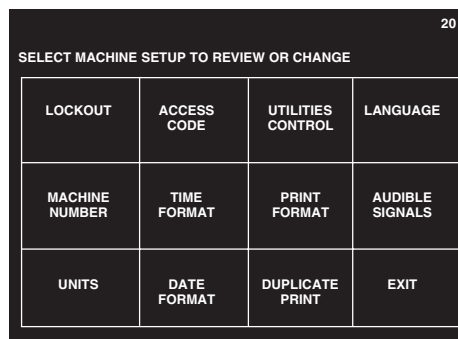

3. If the Access Code option is already turned on, the highlighted touch pad is **CODE REQUIRED**. If the Access Code is not on, highlighted touch pad is **CODE NOT REQUIRED**. Additionally, if the Access Code is not enabled, the **LOCKOUT** button does not appear on screen #20. Press appropriate touch pad if you want to change Access Code status, or press **EXIT**, if no change is necessary.
 - **CODE REQUIRED**. Press **CODE REQUIRED** touch pad. The display changes to screen #35. This screen prompts for the entry of a four digit code.

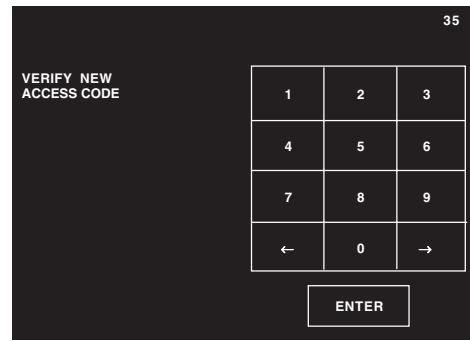
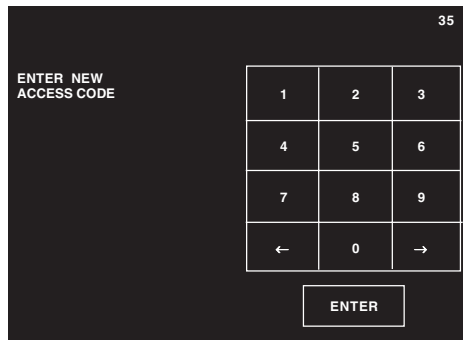

- a. Use the touch screen key pad to enter the access code.
 - b. Once entered, screen prompts for Code to be re-entered for verification. If codes do not match, the control returns to screen #21.
 - c. If codes match, control returns to Change Machine Setup screen (#20).
- **CODE NOT REQUIRED.** If the **CODE NOT REQUIRED** touch screen pad is highlighted and an Access Code is not required, press the **EXIT** touch screen pad. The display returns to the Change Machine Setup screen (#20).
4. If the Access Code is already enabled and **ACCESS CODE** touch screen pad is pressed at the Change Machine Setup screen (#20); the display advances to screen #37 and the control prompts the user to enter the Access Code.
 - a. Enter Code using the touch pads at the right of the screen.
 - b. Once the Code has been entered, press the **ENTER** touch screen pad to advance to Select Access Code screen (#21).
 5. If the status of the Access Code does not need to be changed, press **EXIT** to return to the Change Machine Setup screen (#20).

Entering the Access Code, Once Set

Once the Access Code has been set, any locked out functions or cycle values are protected from unauthorized access. If any of these locked out functions are selected, screen #37 appears on the display.

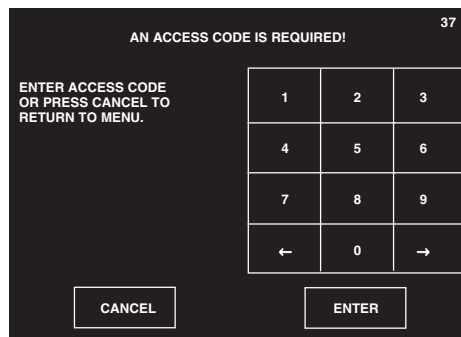

1. If the code is known, enter it using the touch screen key pad. Once the entire four digit code has been entered, press the **ENTER** touch screen pad. The access code digits are not displayed.
2. If the code is not known, press **CANCEL** to return to the previous screen.

5.8 Lockout

This function is used to protect selected setup options from changes by unauthorized personnel. Any functions selected for lockout cannot be accessed without first entering the correct Access Code. Items can also be unlocked at this screen. Small lock graphics are displayed in upper left hand corner of each touch pad indicate if item is locked or unlocked. (🔓 =unlocked, 🔒 = locked.)

1. To access this utility:
 - a. Press **MENU** touch screen pad from the Status screen (#1) at the operating end of the sterilizer.
 - b. The screen changes to show the Menu screen (#2).
 - c. Press the **CHANGE MACHINE SETUP** touch screen pad, the display changes to the Setup screen (#20).

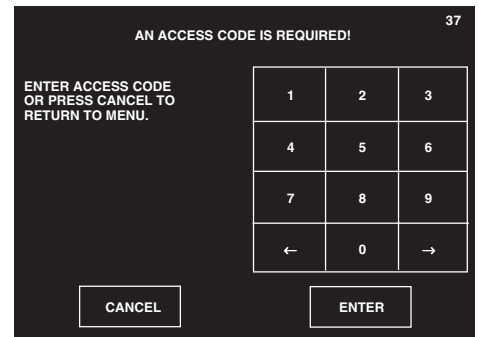
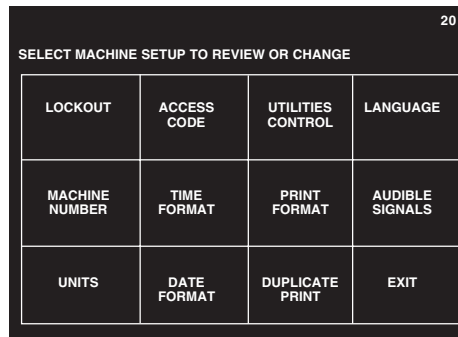

2. Press **LOCKOUT** touch screen pad on the Setup menu screen (#20). The display changes to show the Enter Access Code screen (#37).

NOTE: This occurs only if an Access Code is required; otherwise the unit advances to screen #23.

- a. Enter the code and press **ENTER**. The display advances to the Select Items to Lockout screen (#23).
- b. If the code is not known, lockouts cannot be performed, press **CANCEL** and display changes to screen #20.
- c. If the wrong Access Code is entered, Access Denied screen (#36) appears and returns to screen #20.

3. Press the touch screen pad for the setup options to be locked out. The small lock graphic in the upper left corner of the screen changes to reflect the lockout status.

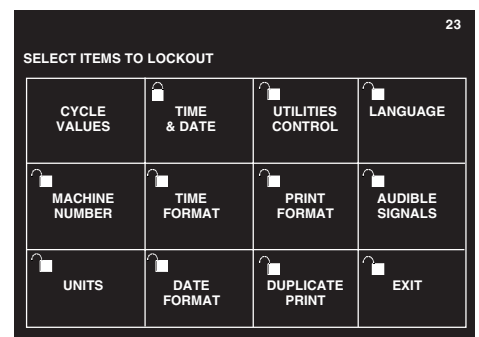
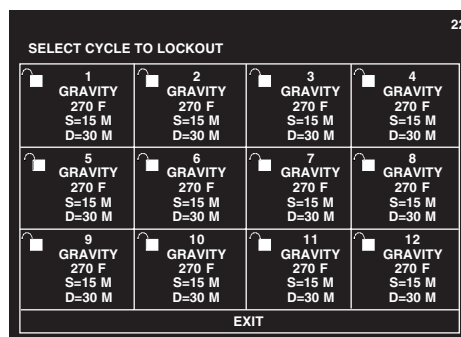

4. To select individual cycles to lock out, press **CYCLE VALUES** touch screen pad. The display changes to the Select Cycles to Lockout screen (#22).
 - a. Press the touch screen pad(s) for the cycles you want to lock out. The lock graphic in the corner of the pad changes to reflect the lockout status.
 - b. Press **EXIT** to return to the Lockout screen (#23).
5. When all setup options to be locked out have been selected, press **EXIT** to return to the main setup menu.

5.9 Utilities Control

This screen is used to automatically control utility services to the sterilizer. As shipped from the factory, this utility is set to Manual Utilities Control (i.e., utilities must be shut off and turned on by an operator). Using this utility, the sterilizer can be set to control the following:

- Daily shut off time
- Daily start up time
- Start up and shut off times for all week days
- Start up and shut off times for weekend days



Screen displayed in Auto Utility Shutdown.

If the sterilizer is processing a cycle when the utility shut down time arrives, the cycle completes before the sterilizer shuts itself off. The sterilizer can be manually restarted for 30 minutes at any time during utility shutdown by pressing the ON touch screen pad at the Off/Standby screen (#0).

1. To access this utility, press the **MENU** touch screen pad from the Main Status screen (#1) at the operating end of the sterilizer.
2. The display changes to the Menu screen. Press the **CHANGE MACHINE**

SETUP touch screen pad. The display changes to the Setup screen (#20). Press the **UTILITIES CONTROL** touch screen pad. The screen changes to the Utilities Control screen (#39).

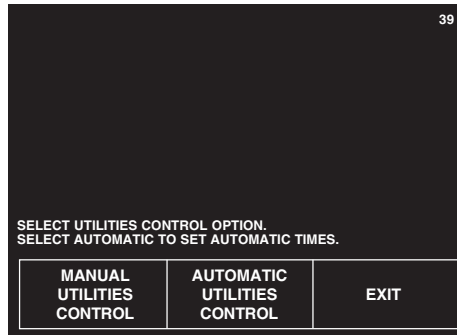

- **MANUAL UTILITIES CONTROL.** This is the default condition for the sterilizer. Press this touch screen pad to cancel all automatic utilities controls. Press **EXIT** to return to the Change Machine Setup screen (#20).
- **AUTOMATIC UTILITIES CONTROL.** Press this to advance to screen #34.

NOTE: For sterilizers run exclusively on night shifts, it may be useful to set shutdown and restart times so the sterilizer operates during the evening hours, and is shut down during the day. The diagram below shows one example of how this can be done.

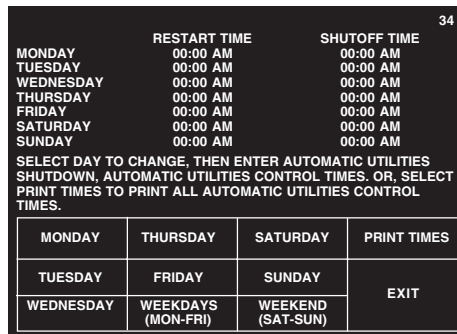
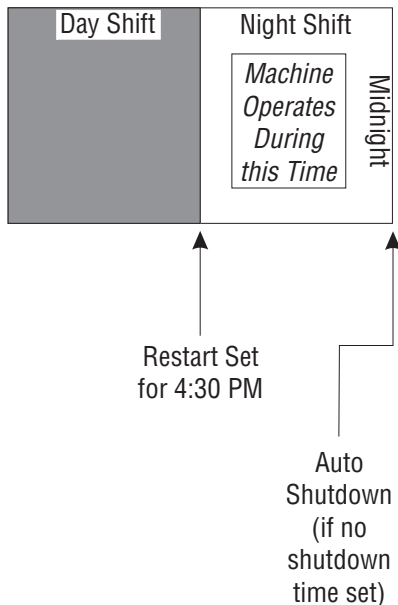

- A range of days can be selected by pressing either the **WEEK-DAYS/(MON – FRI)** or the **WEEKEND/(SAT – SUN)** touch pads. To select a specific day (or days) to adjust Utilities Control, press the appropriate touch screen pad.
- The display changes to screen #33. At this screen the start up times and shut off times are entered using the touch screen key pad. The time is entered as a four digit number (e.g., 0600 for 6:00). Press the **AM** or **PM** touch pad for morning or evening as appropriate.

33

RESTART TIME		SHUTOFF TIME	
ENTER WEDNESDAY SHUTOFF TIME, SELECT "RESTART TIME" TO SET, OR SELECT "OFF ALL DAY"			
SHUTOFF TIME = 00:00 AM			
1	2	3	AM
4	5	6	PM
7	8	9	NONE
←	0	→	EXIT

NOTE: when setting the Utilities Control, note the following:

- 1) If 24 hour (military time) is selected, AM and PM buttons will not be displayed.
 - 2) The times entered for start up and shut down apply to all the days in the selected range.
 - 3) The **NONE** touch pad is used to set no start up or shut off times for the selected day(s). **NONE** can be used to turn off utilities for any or all days in the range. Screen #34 will show **OFF ALL DAY** for the selected day(s).
3. Once the start up and shut off times have been selected, press **EXIT** to return to the Change Machine Setup screen (#20).

See the following example to program automatic utilities control:

Example: The sterilizer is to be used five days a week (Monday through Friday), with a daily start up time of 7:00 am and a shut down time of 6:30 pm. The sterilizer will also be used Saturday morning from 6:00 am through noon.

1. At screen #20, press the **UTILITIES CONTROL** touch pad.
2. At screen #39, press the **AUTOMATIC UTILITIES CONTROL** touch pad.
3. At screen #34, press the **WEEKDAYS** touch pad.
 - a. Enter the 7:00 am restart time by pressing **0 7 0 0** then the **AM** touch pads.
 - b. Press the **SHUTOFF TIME** touch pad.
 - c. Enter the 6:30 pm shut off time by pressing **0 6 3 0** then the **PM** touch pads.
 - d. Then press the **EXIT** touch pad.
 - e. At screen #34 press the **SATURDAY** touch pad.
 - f. Enter the Saturday restart time by pressing the **0 6 0 0** then the **AM** touch pads.
 - g. Enter the Saturday shut off time by pressing the **1 2 0 0** then the **PM** touch pads.
 - h. Then press **EXIT**.
 - i. Finally, at Screen #34, press **SUNDAY**, and at screen #33 press **NONE**.

The utilities control function is now programmed to turn the sterilizer's utilities on at 7:00 am and off at 6:30 pm Monday through Friday. On Saturday the utilities will be on between 6:00 am and noon. Utilities will be off all day Sunday.

5.10 Language

The Century sterilizer is capable of operation with display screens and printouts in two of three languages. The factory default is ENGLISH. A BILINGUAL option can be used to easily change languages between shifts when workers are not familiar with a given language.

1. To access this utility, press the **MENU** touch screen pad from the main status screen (#1) at the operating end of the sterilizer. The screen changes to show the Change Machine Setup screen (#20).
2. Press the **LANGUAGE** touch screen pad on the Change Machine Setup screen (#20). The display advances to show Select Language screen (#28).
3. Select the appropriate language by pressing one of the touch screen pads in the middle of the display.

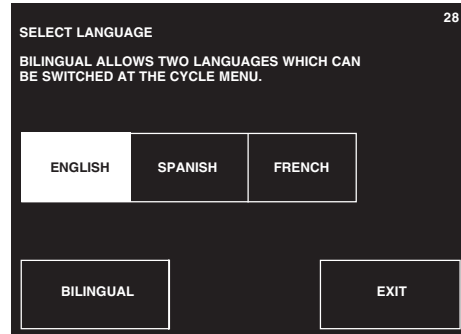

4. The **BILINGUAL** option can be selected to allow operators to toggle between English and the other language available without entering Change Machine Setup. The other language touch pad appears on the main menu. In this way, another language can be selected during operation without going to the CHANGE MACHINE SETUP menu.
5. Once the appropriate language is selected press **EXIT** to return to the Change Machine Setup screen (#20).

5.11 Machine Number

This is used to enter an identifying, two character code into the sterilizer control. This code can be letters, numbers or a combination of both. This code is then printed out in the header for each cycle, allowing for processed goods to be traced back to a specific sterilizer when needed. If this option has been set to a value between 1 and 9, cycle complete tone sounds the set number of times.

1. To access this feature, press the **MENU** touch screen pad at screen #1: at screen #2 press **CHANGE MACHINE SETUP**. The display advances to screen #20.
2. At screen #20, press **MACHINE NUMBER** touch pad; the display advances to screen #41.

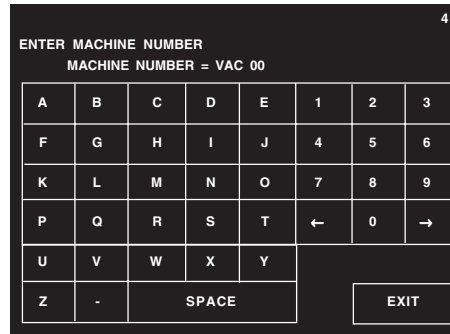

3. At screen #41, enter the two character code for the sterilizer. Any letter, number or combination can be used as the machine number. Ensure, however, that each machine number used is different from any others that have been used in the facility.

NOTE: Dash and space touch pads have been provided.

4. Once the machine number has been entered, press **EXIT** to return to screen #20.

5.12 Time Format

This setup option allows the operator to select the “format” for the time. The format determines how hours and minutes are displayed. There are two options — the default format shows time in the standard format (referred to as AM/PM); the optional format shows time in 24 HOUR (or military).

1. To access this utility, press **MENU** touch screen pad from the main status screen (#1) at the operating end of the sterilizer. The screen changes to show the Menu screen (#2). Press **CHANGE MACHINE SETUP** touch screen pad, the display advances to screen #20.
2. At screen #20, press **TIME FORMAT** touch screen pad. The display advances to screen #30.

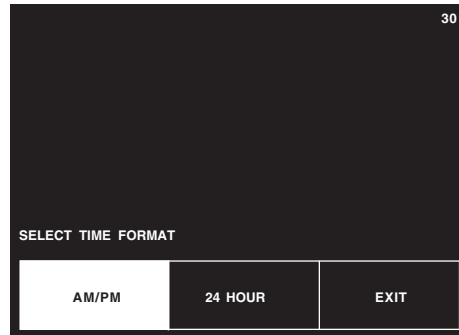

3. Select the appropriate time format by pressing one of the two touch screen pads in the lower half of the display.
 - **AM/PM** — This is the standard civilian time format.
 - **24HRS** — This is a 24 hour format associated with military timekeeping.
4. Once the appropriate format has been selected, or if format does not need to be changed, press **EXIT** to return to the Change Machine Setup screen (#20).

5.13 Print Format

```

===== F L A S H =====
CYCLE START AT 7:36:05A
                ON 2/21/98

LOAD           022103

TEMP MAX=273.7F
TEMP MIN=270.0F

CONDITION     = 2:51
STERILIZE     = 3:00
EXHAUST       = 2:10
TOTAL CYCLE   = 8:01

PRINTOUT CHECKED BY:

-----
* NOT READY   7:44:47A
DOOR OPEN
-----

```

Condensed Printout (Typical)

```

===== F L A S H =====
CYCLE START AT 7:51:20A
                ON 2/16/98

CYCLE COUNT           17
OPERATOR -----
STERILIZER   VAC 00

STER TEMP = 270.0F
CONTROL TEMP = 273.0F
STER TIME = 3 MIN
DRY TIME = 1 MIN

                U=inHg
- TIME         T= F  P=Psi
-----
C 7:51:32A 205.7   0P
C 7:52:32A 249.9  10P
S 7:53:46A 270.0  28P
S 7:54:46A 273.3  30P
S 7:55:46A 272.8  30P
S 7:56:46A 272.8  31P
E 7:56:46A 272.8  31P
E 7:57:09A 231.7   3P
E 7:58:09A 207.0  26U
Z 7:58:55A 211.1   2U

LOAD           021604

TEMP MAX=273.7F
TEMP MIN=270.0F

CONDITION     = 2:14
STERILIZE     = 3:00
EXHAUST       = 2:09
TOTAL CYCLE   = 7:23

PRINTOUT CHECKED BY:

-----
=  READY TO UNLOAD  =
-----

```

Full Printout (Typical)

This setup option allows the operator to select the cycle printout “format.” The format determines the type of printout the sterilizer provides during processing. Two options are available. The default FULL format provides status prints at each transition point in the cycle, plus additional status at interval points during each phase of the cycle. The optional CONDENSED format provides a cycle summary and complete time, without additional status prints at cycle interval points. The CONDENSED format can be used to conserve printer paper.

1. To access this utility, press the **MENU** touch screen pad from the Status screen (#1) at the operating end of the sterilizer. The screen changes to show the Menu screen (#2). Press the **CHANGE MACHINE SETUP** touch screen pad.
2. Press **PRINT FORMAT** touch screen pad on the Change Machine Setup screen (#20); the display advances to screen #29.

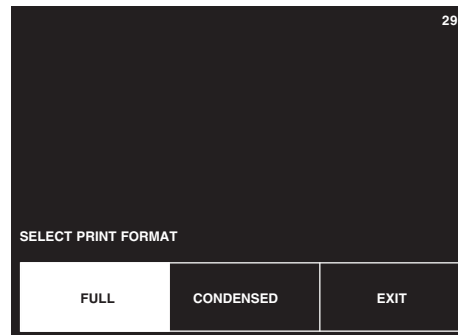

3. Select the appropriate print format by pressing one of the two touch screen pads in the lower half of the display.
 - **FULL** — This is the standard format providing a status print for each phase of the cycle and status prints at the predetermined Print Interval.
 - **CONDENSED** — This format provides an abbreviated cycle status printout.
4. Once the appropriate format is selected, press **EXIT** to return to the Change Machine Setup screen (#20).

5.14 Audible Signals

This setup option allows the operator to adjust selected audible signals heard at the sterilizer control. Three signals can be adjusted. Touch pad and end of cycle signals can be adjusted to one of three volume levels or turned off. Only the volume level of the Alarm signal can be adjusted. The Alarm signal cannot be turned off.

1. To access this utility, press the **MENU** touch screen pad from the Status screen (#1), at the operating end of the sterilizer. The screen changes to show Change Machine Setup screen (#20).
2. Press **CHANGE MACHINE SETUP** on the menu screen, then **AUDIBLE SIGNALS** on the Setup screen (#20). The display advances to the Audible Signals setup screen (#24).

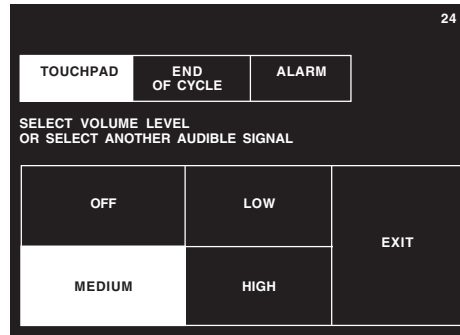

3. Select the signal you wish to adjust by pressing the appropriate touch screen pad in the upper half of the screen.
 - **TOUCHPAD** — This is the signal sounded by the control whenever anyone presses a touch screen pad.
 - **END OF CYCLE** — This is the signal heard when a cycle is complete.
 - **ALARM** — This is a two-tone signal heard during abnormal conditions.
 - a. Each audible signal can be adjusted for volume.
 - 1) First press the touch screen pad for the selected type of signal (e.g., **ALARM**, **END OF CYCLE** or **TOUCHPAD**).
 - 2) Once the signal has been selected, press the required volume level (e.g., **LOW**, **MEDIUM** or **HIGH**).
 - b. **TOUCHPAD** and **END OF CYCLE** provide an **OFF** setting. The **ALARM** signal cannot be turned off.
4. Once the appropriate Audible Signals and Signal volumes have been selected, or if these do not need to be changed, press **EXIT** to return to the Change Machine Setup screen (#20).

5.15 Units

This feature is used to select or change the units the sterilizer uses when displaying and printing chamber temperature and pressure. This function allows selection of either Fahrenheit or Celsius units for displaying and printing temperature. Pressure units can be changed between psig/inHg or bars. Changing units does not require recalibrating the sterilizer.

1. To access this feature, press the **MENU** touch screen pad at screen #1; at screen #2 press **CHANGE MACHINE SETUP**. The display advances to screen #20.
2. At screen #20, press **UNITS** touch screen pad, the display advances to screen #42.

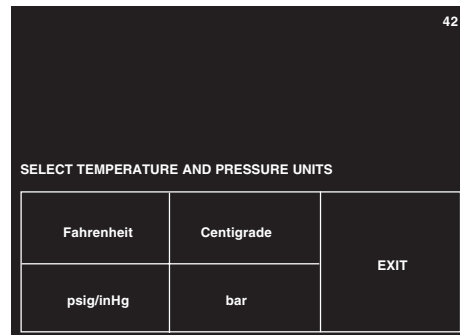

3. At screen #42, press the appropriate touch screen pad for the type of unit or units required. Once all units have been selected, press **EXIT** to return to screen #20.

5.16 Date Format

This setup option allows the operator to select the “format” for the date. The format determines the order in which the month, day and year are displayed. There are three options, and the option selected is a matter of either preference or geographical location.

1. To access this utility, press the **MENU** touch screen pad from the Status menu (#1). Press the **CHANGE MACHINE SETUP** touch pad, the control advances to the Change Machine Setup screen (#20).
2. Press **DATE FORMAT** touch screen pad at screen #20; the display advances to screen #26.
3. Select the date format appropriate for your location by pressing one of the six touch screen pads in the lower half of the display.

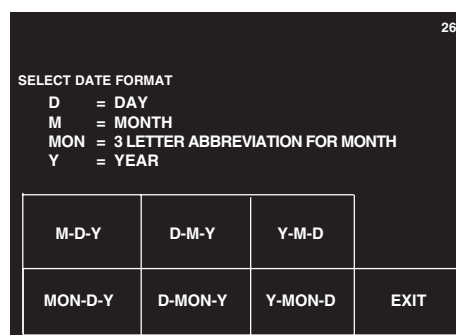

- **M-D-Y** — Month-Day-Year
- **D-M-Y** — Day-Month-Year
- **Y-M-D** — Year-Month-Day
- **MON-D-Y** — Month-Day-Year*
- **D-MON-Y** — Day-Month-Year*
- **Y-MON-D** — Year-Month-Day*

**When selecting the format touch pads in the bottom row, MON = 3 letter abbreviation of the month.*

4. Once the appropriate format has been selected, or if format does not need to be changed, press **EXIT** to return to the Change Machine Setup screen (#20).

5.17 Duplicate Print

This setup option allows the customer to select whether the sterilizer automatically supplies an extra printout at the end of the cycle. There are two options, the option selected depends on operating requirements in your facility. The default setting is for no duplicate print.

1. To access this utility, press **MENU** touch screen pad from the main status screen (#1) at the operating end of the sterilizer. The screen changes to show the Menu screen (#2). Press **CHANGE MACHINE SETUP** touch screen pad; the display advances to screen #20.
2. Press **DUPLICATE PRINT** touch screen pad on the Change Machine Setup screen. The display advances to screen #27.

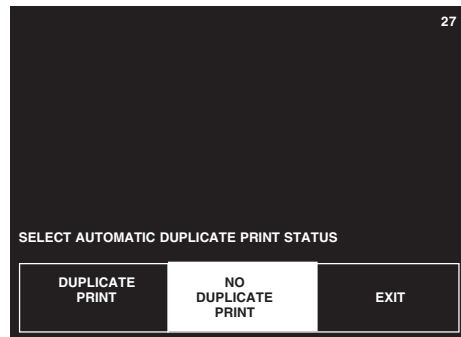

3. At screen #27, select the appropriate print option by pressing one of the touch screen pads in the lower half of the display.
 - **DUPLICATE PRINT** — The sterilizer provides a second printout of the last previous cycle after the cycle completes.
 - **NO DUPLICATE PRINT** — This is the normal default setting. The sterilizer does not provide an additional printout at the end of the cycle.
4. Once the appropriate format has been selected, or if format does not need to be changed, press **EXIT** to return to the Change Machine Setup screen (#20).

5.18 Leaving Change Values

1. Press **EXIT** at screen #20 to return to Menu screen #2.
2. Press **EXIT** at screen #2 to return to Status screen #1.